

ALTAIR

SUGGESTED TOOLS AND MATERIALS



Pencil



Safety Glasses

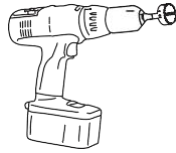

Drill

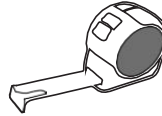

Tape Measure

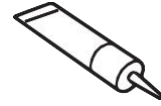

Silicone Adhesive

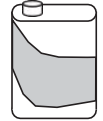

Acetone

PARTS LIST

- Sink
- Sink Faucet (not included)
- Sink Drain (not included)

NOTE: Specialized tools may be necessary to install a Vessel Sink with countertop materials other than wood, marble, or granite.



1. Read the complete instruction manual before beginning installation.
2. Confirm that your model will fit in intended location and plumbing fixtures are located where legally required before beginning installation.
3. Two people are recommended to install and move this product.

1. Mark Faucet Holes and Drain Location

- Place sink in desired location on countertop and mark the drain hole and faucet hole with a pencil.

NOTE: Make sure clearance is suitable for backsplash, faucet, and plumbing for the sink.

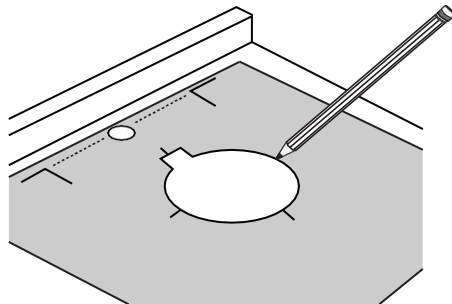

2. Drill Countertop

- Cut the opening for the drain in the countertop.

ALWAYS WEAR PROTECTIVE GEAR WHEN USING DANGEROUS MATERIALS

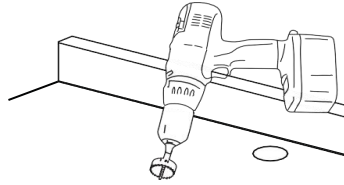

3. Install Faucet

- Install faucet and its components.

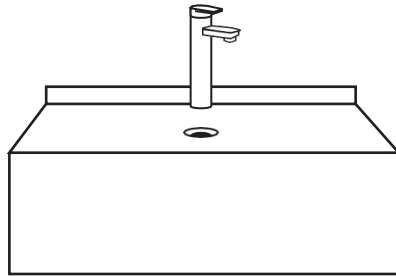

4. Install Sink

- Check alignment of the sink to the opening in the countertop.
- Use a bead of clear silicone (or preferred adhesive) around the underside of the sink.
- Carefully place the sink on the countertop, align, and press firmly.
- Allow sealant to set above 60 minutes.

Installer Tip: Use acetone or denatured alcohol to remove any excess sealant immediately after application.

