

Handle Removal Maintenance

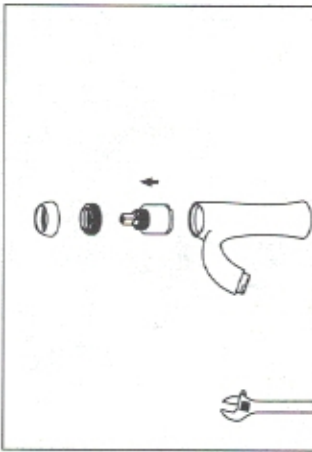

Turn off water and relieve pressure! Detach handle button using a small flathead screwdriver, unscrew set screw using Allen Wrench and take off handle.

Valve Cartridge Removal Maintenance



Remove handles. Unscrew Dome Cap counter clockwise by hand. Unscrew Retaining Nut using adjustable wrench, take out cartridge assembly and inspect. Replace parts as necessary. Reassemble parts by reversing steps.

CAUTION: Maintenance

Replacement parts may be available at the store where you purchased your faucet. Always turn off water and relieve pressure before working on your faucet.

NOTES: Cleaning Instructions

To keep the faucet clean, you should clean the faucet frequently and regularly. Clean the faucet with clear water or mild liquid, rinse the faucet with clear water and then dry the faucet with soft cotton cloths. Do not use any abrasive cleansers, cloths, or paper towel. Do not use any acid or abrasive detergent.

DOUBLE-SHOOTING

If you've followed the instruction carefully and your faucet still does not work properly, take these corrective steps.

Problem	Cause	Action
Leaks underneath handle.	Cartridge has come loose.	Tighten the cartridge.
Aerator leaks or has an inconsistent water flow pattern.	Aerator is dirty or worn out or misfitted.	Unscrew the aerator to clean or replace washer, or replace the aerator.
Water will not shut off completely.	Dirty or worn out washer in cartridge.	Remove handle and cartridge to check if the washer is damaged permanently or dirty. Re-install cartridge.

Basin Faucet

PACKING LIST

After you open this package, please check to ensure that all of the following items are included.

A-Faucet B-Mounting Nut C-Flexible Hoses(2) D-Allen wrench

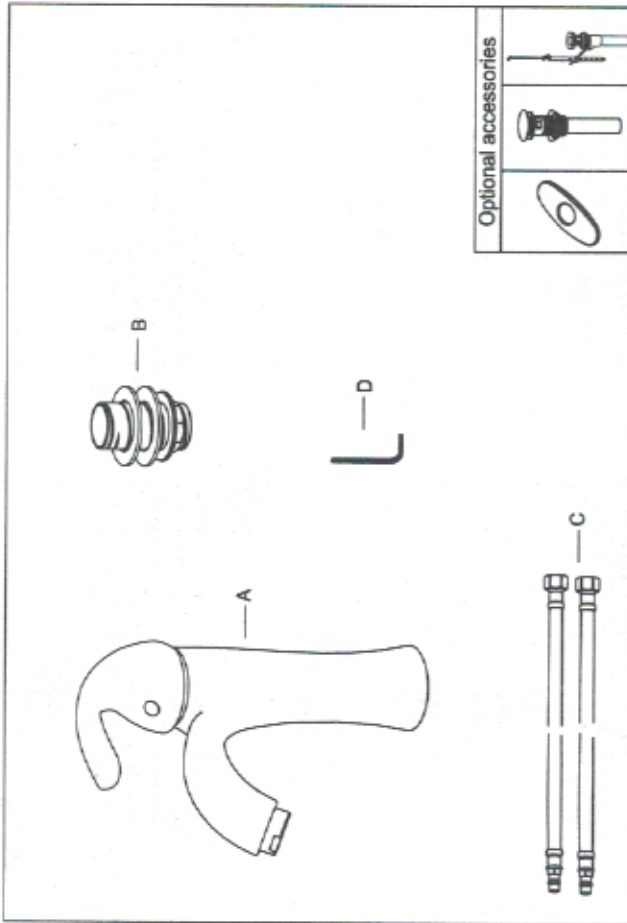

IMPORTANT NOTICES: For easy installation, please read all the instruction completely before beginning. Before installing this product, make sure that water line trash is cleared to avoid blockage.

YOU MAY NEED

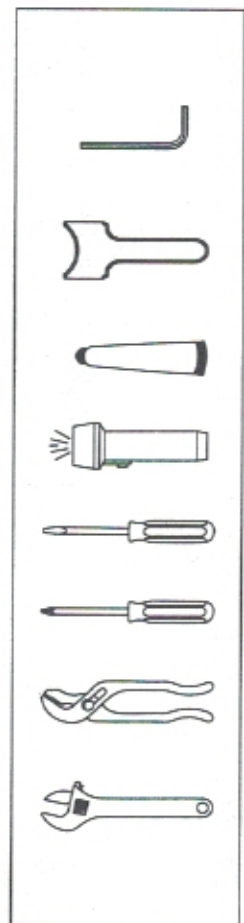

INSTALLATION PROCEDURES

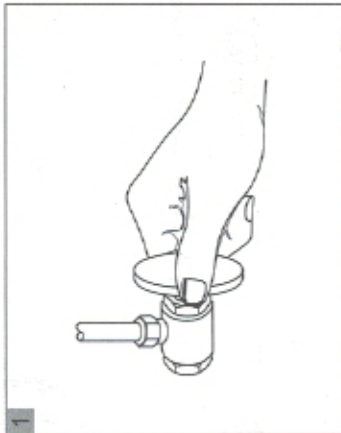

1 You should clean all the dirt from valves outlets. Turning off the water supply valves. This is usually found near the water meter. If you are replacing an existing faucet, remove the faucet from the sink and clean the sink surface thoroughly.

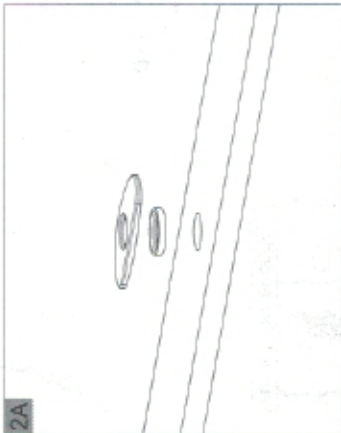

2A Install with Deck Plate. Place a bead of plumber's putty between faucet and sink. Place Deck Plate over the three holes of sink. From underside sink, tighten Wing nut.

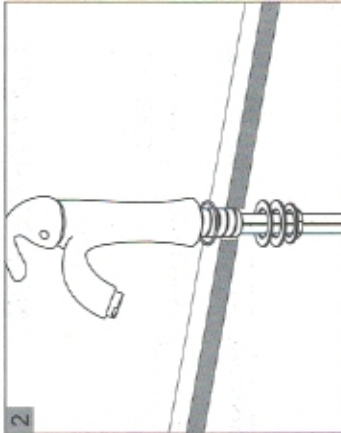

2 Install without Deck Plate. Make sure the O-RING is placed onto the bottom of Base Ring. Install faucet through hole in sink. From underside sink, put Plastic Washer and Mounting Nut. Position faucet on sink properly and tighten Mounting Nut.

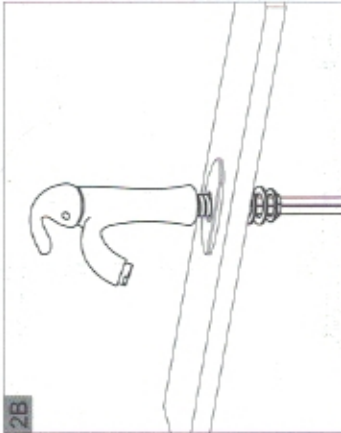

2B Make sure the O-RING is placed onto the bottom of Base Ring. Install faucet through Deck Plate. From underside sink, put Plastic Washer and Mounting Nut. Position faucet on sink properly and tighten Mounting Nut.

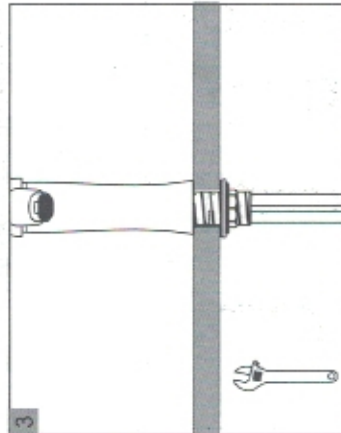

3 If necessary, tighten screws using an adjustable wrench until the faucet is firmly connected to the sink.

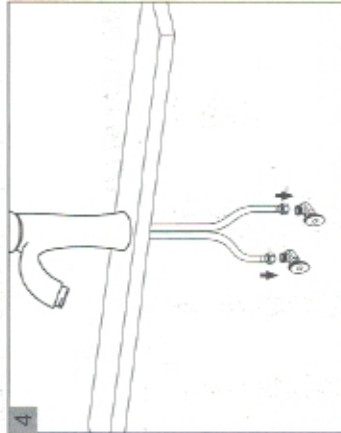

4 Connect hot and cold water supply lines to the Water Supply Valves.

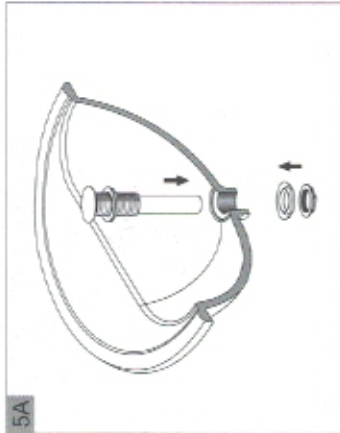

5A Unscrew Locknut. Make sure the Rubber Washer is in the right position under Flange. Insert Pop-up Assembly into Sink drain Hole. From underneath, tighten with Lockset.

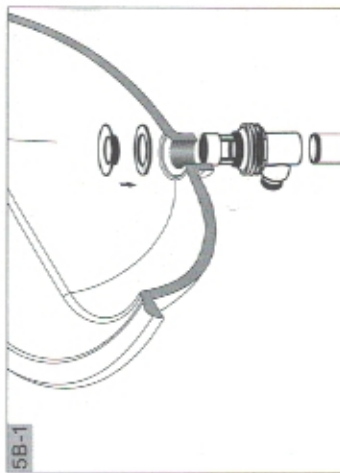

5B-1 As shown. Insert Flange with Washer through Sink drain Hole. From underside, thread Drain Body into Flange. Holding the drain body in position with Ball Rod Opening facing back, tighten Metal Locknut securely. Thread Drain Tailpiece into Drain body.

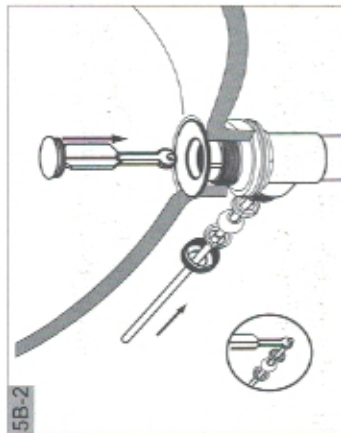

5B-2 As shown. Place the Drain stopper into the drain body from the top rear. Slide the ball rod into the Ball Rod Opening through Stopper Hole, and threaded it on to the Drain Body.

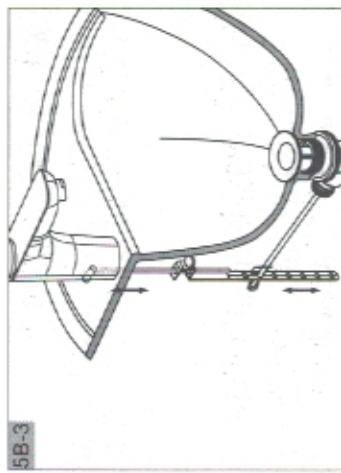

5B-3 Insert Lift Rod through Lift Rod Strap and secure with Set Screw. Place the Ball Rod through one of the holes on the Lift Rod Strap. Secure it with the Spring Clip. Adjust the height of the lift by resetting Set Screw. No interference between faucet and knob.

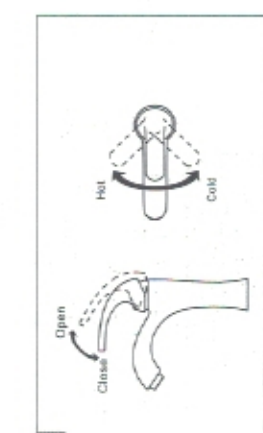

6 Lift the handle up, the cartridge will be activated allowing water to flow. The water flow will increase by continuing to rotate handle. By rotating the handle to the right, the water temperature will decrease to cold flow only. By rotating Handle to the left, the water temperature will increase to hot only.

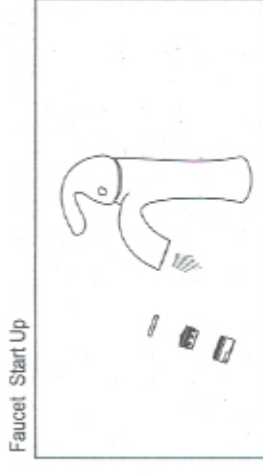

Faucet Start Up

After installation is complete, remove aerator and rotate handle to the closed position. Turn on the water supply valves, and check all connections for a leak. Turn on your faucet and allow both hot and cold water to run at least one minute each. Replace Aerator.