

60 IN. TILE INSERT LINEAR SHOWER DRAIN

CAT160

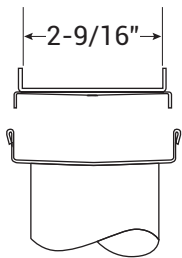

Side View

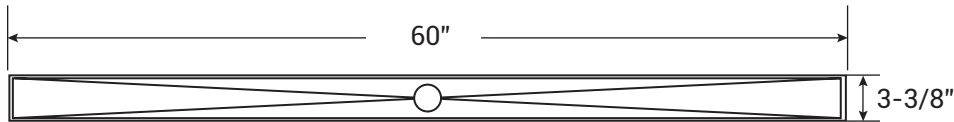
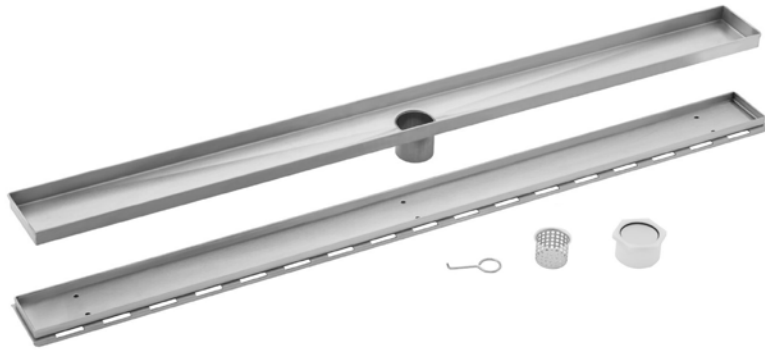
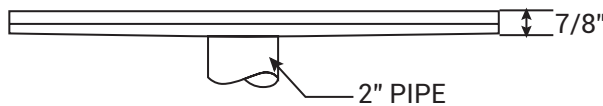

FEATURES

MODEL	CAT60
SIZE	3-3/8" W x 60"L x 7/8"H
FINISH	Brushed Stainless Steel
MATERIAL	Stainless Steel
DRAIN	9 GPM Drain Rate

- Sloped inner channel funnels water toward a central drain for maximum water removal
- Removable tile tray for easy cleaning & maintenance
- Basket filter included
- Suitable for installation with all decorative tile, natural stone, and solid surface flooring materials.

BEFORE YOU BEGIN INSTALLATION

- Carefully Read the instructions before starting installation.
- This product should be installed by an experienced professional.
- Drain pipe is not supplied. Connect to an existing drain pipe.

If you are missing any part, please stop and contact us immediately at (205) 702-9101.

60 IN. TILE INSERT LINEAR SHOWER DRAIN

Installation Instructions

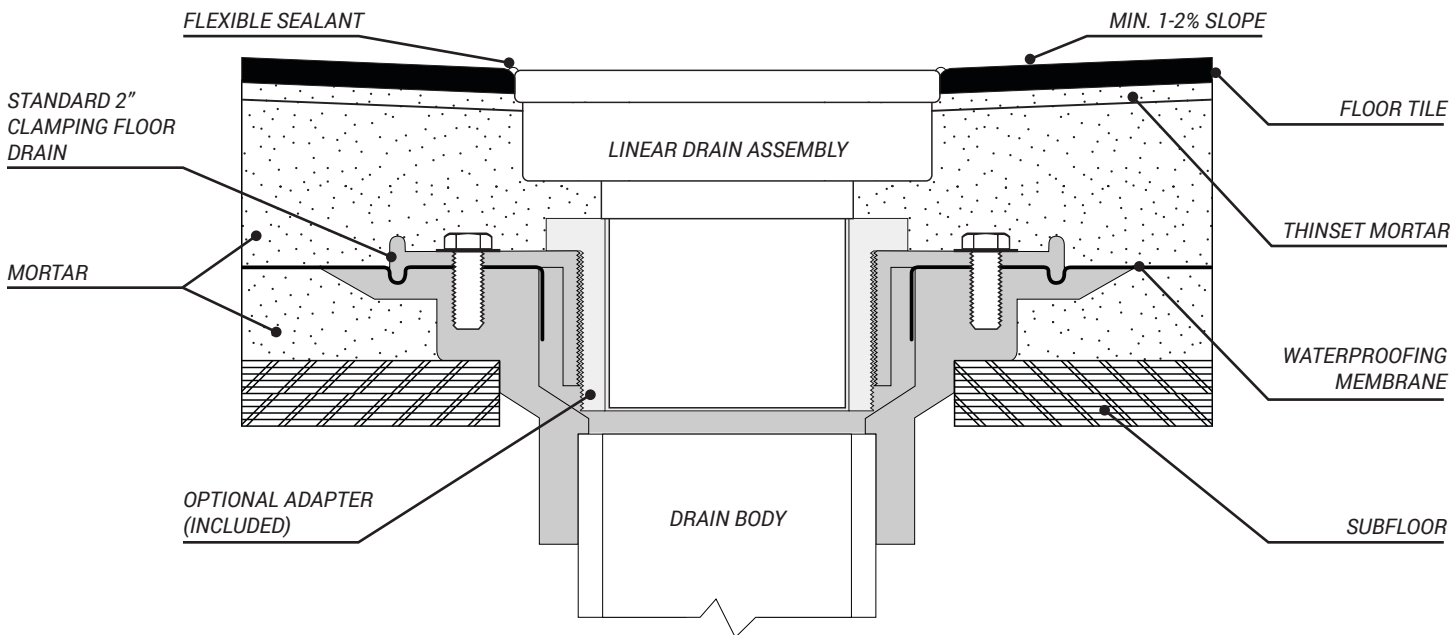

PREPARE SHOWER PAN

1. Pre-slope shower pan and install waterproofing membrane per manufacturers instructions.
2. Perform a leak test as required.

IMPORTANT: Any waterproofing membrane material or procedure can be used: vinyl, CPE membrane, roll or paint on, metal pan, hot mop, surface sheet membrane.

PRE-INSTALLATION PREPARATION

1. The Linear Drain channel width is 3-3/16". Confirm the rough opening is approximately 2" wider than the drain length to accommodate backer board and wall tile thickness.
2. Install the Standard 2" Clamping Floor Drain (not included).

3. Cut a 2x4 to length for use as a Linear Drain placeholder. This allows for a 1/8" gap around the channel's perimeter to apply a bead of flexible sealant.

NOTE: Channel depths are 1.25" for the Tile Insert Linear Drain and .78" for the Grate Linear Drains.

TILE INSTALLATION

1. Using mortar, build up the shower base.
2. Slope the mortar creating a 1-2% grade towards the drain.

3. Using a thinset mortar, install the floor tile and entire shower alcove.
4. If using Tile Insert Linear Drain, install the tile into the tile insert tray.
5. Grout, clean and seal all tile in the shower area.

IMPORTANT: Allow the mortar to cure overnight before installing tiles.

60 IN. TILE INSERT LINEAR SHOWER DRAIN

Installation Instructions



LINEAR DRAIN INSTALLATION

1. Remove the 2x4, clean out the void.
2. Screw the optional adapter into the drain hub to adjust the height of the channel.
3. Install the linear drain channel as you would any tile, building up and supporting as necessary with mortar. Ensure drain channel is level and just slightly below (1/6" or less) the adjacent tile.
4. Line perimeter of linear drain channel with a color-matching, flexible waterproof sealant.

NOTE: This will allow the stainless steel to expand and contract without damaging the grout or tiles.

5. Assemble the Linear Drain by placing the hair strainer into the channel, then place the tray on top.

IMPORTANT: Use the lift-out key to pull the hair strainer out when you clean the drain.



CHANNEL INSTALLATION & ADJUSTMENT

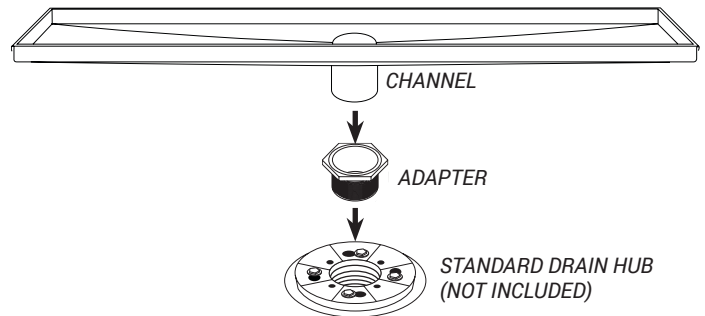

TURN ADAPTER CLOCKWISE TO ADJUST HEIGHT OF CHANNEL

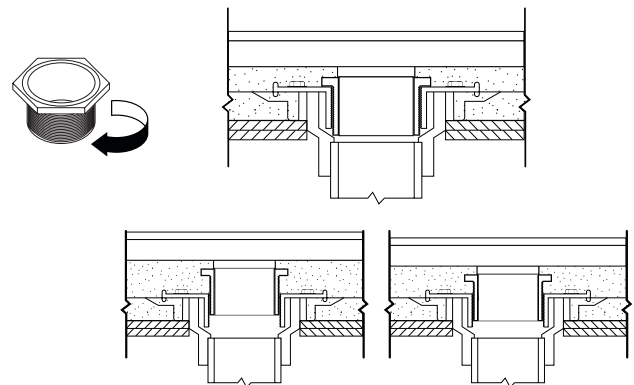

FINAL LINEAR DRAIN ASSEMBLY

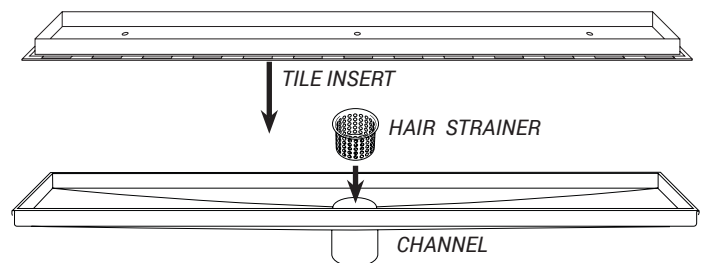

60 IN. TILE INSERT LINEAR SHOWER DRAIN

Care & Maintenance



RECOMMENDED CLEANERS

For stains or light scratches, we suggest a mildly aggressive cleaner. You can also try a paste of baking soda and water, but be sure to rinse well and dry.

For stubborn stains and more noticeable scratches, we suggest a more aggressive cleaner such as Bar Keeper's Friend®. For extremely stubborn stains, you may also try to use a Scotch-Brite™ Pad. When using any of these cleaners, it is critical that you rub in the direction of the grain lines, rinse completely and towel dry.

SUGGESTED MAINTENANCE

- Do not use abrasives, sharp or scraping objects to clean your linear drain.
- The hair catcher should be cleaned periodically to remove any dirt that may have collected during regular use.

CAUTION

- Don't rub the across the satin finish lines. Scouring across the satin finish lines can damage the original finish.
- Don't allow soap or other household cleansers to dry on the surface of the linear drain. Most brands contain chemical additives which will affect the original finish.
- Don't use solutions of chlorine bleach and water in the drain. Chlorides, which are found in most soaps, detergents, bleaches, and cleansers, are very aggressive to stainless steel. If left too long, they can cause surface pitting.
- Don't leave wet sponges, cloths, or cleaning pads on the linear drain. This can lead to surface rust.
- Don't use a steel wool pad to clean your linear drain. If a more abrasive product is needed, use a green Scotch-Brite™ pad, being sure to rub in the direction of the satin finish lines. Steel wool pads have a tendency to break apart and small particles of steel can become embedded in the surface of the linear drain. The steel particles will rust and will give the appearance that the drain itself is rusting.

60 IN. TILE INSERT LINEAR SHOWER DRAIN

Limited Lifetime Warranty



This product has been manufactured and tested to the highest quality standards by Cahaba. We offer our customers thoughtfully crafted fixtures & accessories, engineered for enduring performance over years of use.

WHO IS COVERED BY THE WARRANTY

This warranty extends to the original purchaser only. This warranty is not transferable, between homes or owners and is only applicable to residential use.

WHAT IS COVERED BY THE WARRANTY

Cahaba warrants this product against defects due to material or craftsmanship error during the warranty period: Cahaba will provide replacement parts at no charge, or at its option, replace any product or part of the product that is deemed defective, under normal installation, use, service and maintenance. If Cahaba is unable to provide a replacement and repair is not practical or cannot be made in timely fashion, Cahaba may elect to refund the purchase price in exchange for the return of the product.

CONDITIONS AND EXCLUSIONS

Like other home fixtures, Cahaba products will require light maintenance to ensure proper function. We provide you with complete knowledge to perform this maintenance and can also recommend resources if you are unable to fulfill this service.

- Cahaba will not be responsible for product failures due to lack of maintenance or proper use. Please read your care and maintenance documentation to determine the limits of proper use.
- The original sales receipt, order number, and/or proof of purchase must be presented at the time of the warranty claim, without exception, for this warranty to be applied to all Cahaba products.
- Cahaba recommends installing all Cahaba products with a licensed, professional plumber. Cahaba will not be held responsible for any damage or product failure due to improper installation, misuse, or failure to use a licensed professional. Please read your care and maintenance documentation to determine the limits of proper use.
- Commercial use will automatically void this warranty.

NON-APPLICABILITY OF THIS WARRANTY

By the purchase and use of our products, you agree that Cahaba is not liable for incidental, consequential or special damages associated with the return, replacement, installation or use of your product. This includes freight costs, cartridge replacement, labor, travel time, lost profit, home damages and other contingent liabilities and costs (including, without limitation, costs associated with experts, investigations, analyses, attorneys and other professionals and services).

The Cahaba warranty is a comprehensive and explicit limit of liability and all items outside of it are not addressable by or the responsibility of Cahaba. Certain states have variances regarding implied warranties and in those situations we remain fully compliant. Cahaba makes no implication that products comply with any or all local building or plumbing codes. It is the consumer's responsibility to determine local code compliance. This warranty extends to the original purchaser and first consumer.