

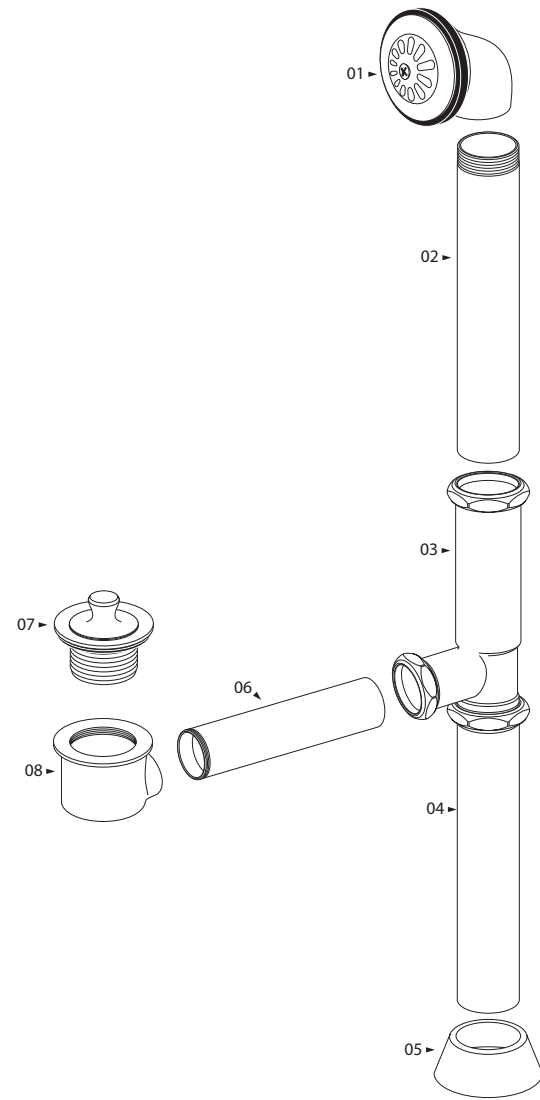

2220 / 2222 / 2647



### 2220 / 2222 / 2647 Waste and Overflow Drain

#### Before Your Installation

- Read all instructions carefully.
- Assemble all tools.
- Turn off main water supply before removing old faucet and fixtures.
- Clean surface before installing new faucet.
- Insert a cloth or stopper into drain to prevent small parts from getting lost.
- Cheviot Products recommends that all products are cleaned only with soap and warm water. Using Abrasive cleaners and/or chemical will void finish warranty

#### Antes de Instalar

- Lea cuidadosamente todas las instrucciones.
- Tenga todas las herramientas a la mano.
- Cierre la llave principal de la tubería de agua antes de quitar el grifo y los accesorios anteriores.
- Limpie la superficie antes de instalar el nuevo grifo.
- Introduzca un trapo o una estopa en el desagüe para evitar que las piezas pequeñas se pierdan.

#### Tips for Successful Installations

- Use joint compound or Teflon® tape on all threaded connections to prevent leaks.
- Use a soft cloth to protect the faucet's finish when using a wrench, pliers or other tools that could scratch the faucet.
- Tighten all hose connections by hand. Do not over tighten.
- Before turning main water supply back on, open several faucets around the house to prevent pressure from building up. Remove aerator from faucet before turning on water. Flush drain for several minutes before replacing aerator. DO NOT use joint compound or Teflon® tape to reconnect aerator.
- If you experience problems with the installation consult a professional plumber.

#### Consejos para una óptima instalación

- Utilice sellador o cinta de Teflón® en todas las conexiones de rosca para evitar fugas.
- Utilice un trapo suave para proteger el acabado del grifo al momento de utilizar una llave de tuercas, pinzas u otras herramientas que pudieran rayar oarañar el grifo.
- Apriete a mano todas las conexiones de manguera. Evite trasroscar.
- Antes de volver a abrir la llave principal del agua, abra varios grifos en la casa para evitar que la presión se acumule.
- Retire el aireador del grifo antes de abrir la llave del agua. Deje correr el chorro varios minutos antes de volver a colocar el aireador. NO UTILICE sellador o cinta de Teflón® para reconectar el aireador.
- En caso de tener problemas con la instalación consulte a un plomero profesional.

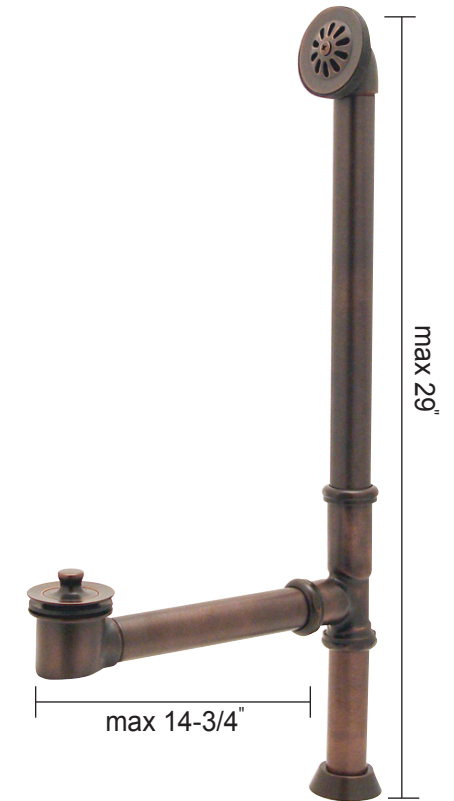

#### Component Parts List

#### Lista de Repuestos

#	PART NAME	QTY
1	OVERFLOW GRID	1
2	OVERFLOW DRAIN PIPE	1
3	T - ELBOW CONNECTOR	1
4	DRAIN TAIL PIECE	1
5	FLANGE	1
6	BOTTOM DRIAN PIPE	1
7	DRAIN GRID & PLUG (LT4283 - LIFT & TURN / LT4183 - PLUG & CHAIN	1
8	BOTTOM DRAIN ELBOW	1

#### Tools You Will Need

#### Herramientas Necesarias

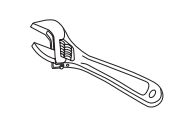

Adjustable Wrench  
Llave Ajustable

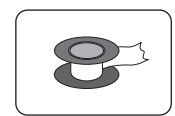

Pipe Tape  
Cinta selladora

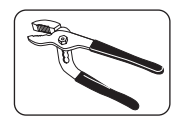

Groove joint plier  
Pinzas ajustables



Silicon Caulking  
Masilla de plomeria

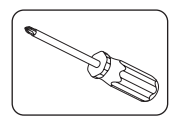

Phillips Screwdriver  
Destornillador cruciforme

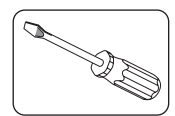

Flathead Screwdriver  
Destornillador

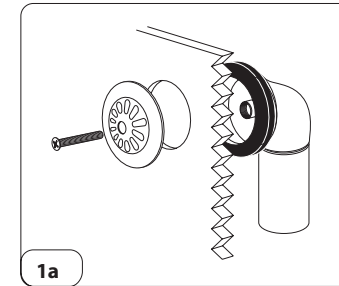
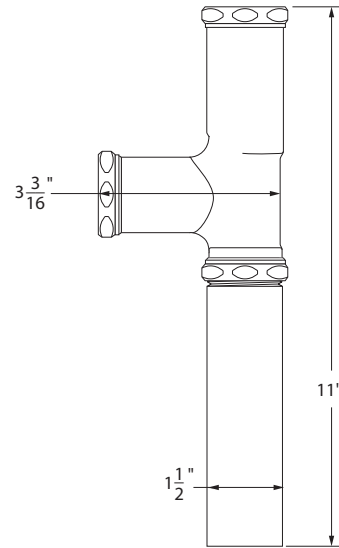
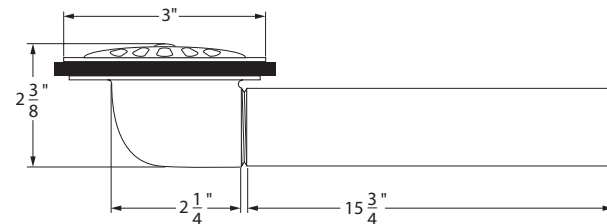
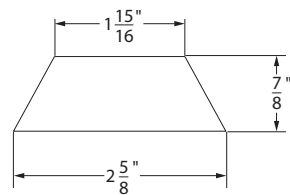
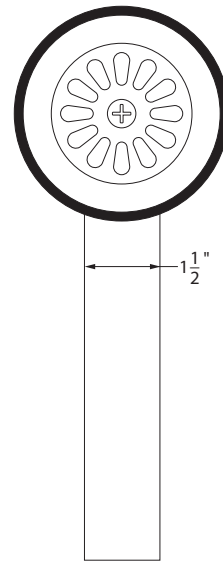
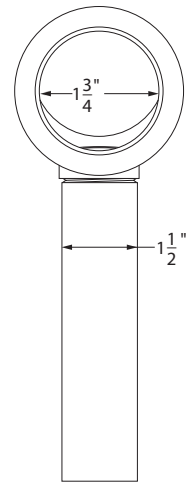
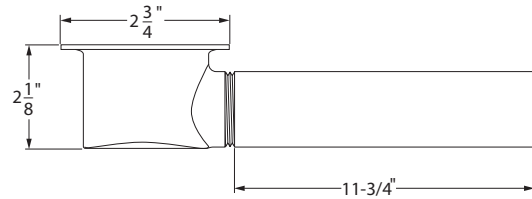
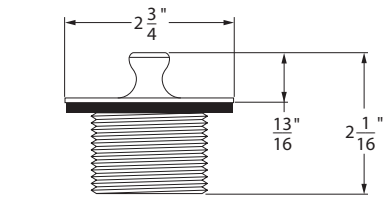

**1a**  
Mount overflow drain pipe to back side of tub wall. Use the thick washer to prevent any water leakage. Fasten the overflow grid to inside wall of the tub by lining the hole up with the threads and screw down until tight. (If you are using the plug and chain model (LT4183) be sure to place the eye loop at one end of the chain around the screw before installing)

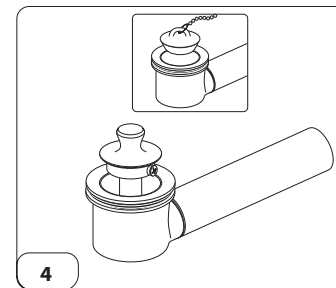
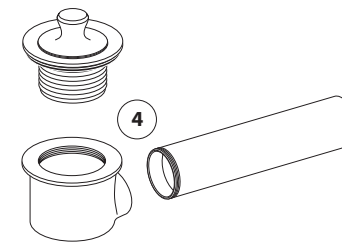

**4**  
Install the drain grid with washer through the top of the drain hole. Screw down until tight. Make sure to adjust drain plug mechanism (lift and turn / plug). To install lift & turn mechanism loosen the screw on the side of the lift plug. Line the screw hole up with the flat side of the stem sticking up from the drain, and tighten the screw in all the way.

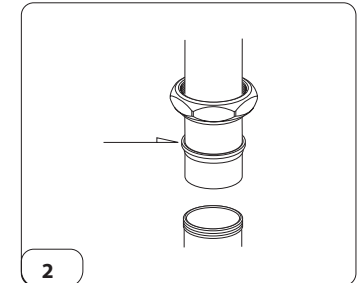
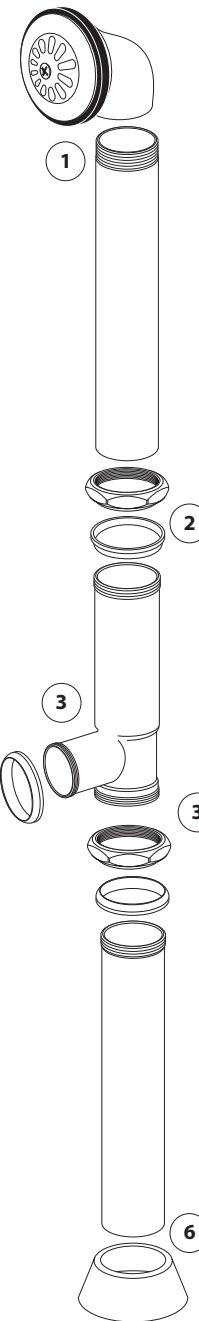

**2**  
First slide the lock nut and packing onto the overflow drain pipe. Next, using the slip joint connection on the T elbow, slide the elbow onto the overflow drain pipe and line up such that the drain pipe on the bottom of the tub can be easily inserted. Once the T elbow lined up slide the packing all the way down and tighten the lock nut over the top until hand tight.

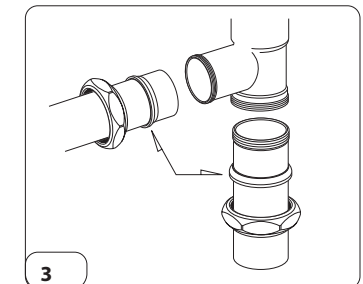

**3**  
Next, slide lock nut and packing onto the bottom drain piece pipe and slide the pipe into the horizontal opening in the T elbow. Line up the drain piece with the drain hole in the tub. Do the same for the bottom tail pipe.

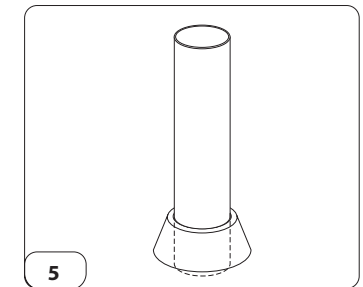

**5**  
After all components are installed place the base flange over the bottom tail pipe before connecting to the waste plumbing line. Connect the waste and overflow to plumbing lines in the floor. Check for any leakage in the assembly.