

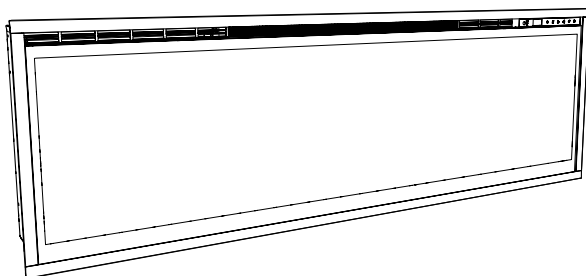

Better solutions through innovation

Owner's Manual

Model
XLF50
XLF74
XLF100











IMPORTANT SAFETY INFORMATION: Always read this manual first before attempting to install or use this fireplace. For your safety, always comply with all warnings and safety instructions contained in this manual to prevent personal injury or property damage.

To view the full line of Dimplex products, please visit
www.dimplex.com

7214410100R05



Table of Contents

 Welcome & Congratulations	3
 IMPORTANT INSTRUCTIONS.	4
 Quick Reference Guide	6
 Fireplace Installation	7
Installation	7
For Bathroom Use.	12
Final Assembly	12
 Operation	14
 Maintenance	19
 Warranty.	20
 Technical Support	22

Always use a qualified technician or service agency to repair this fireplace.

! NOTE: Procedures and techniques that are considered important enough to emphasize.

! CAUTION: Procedures and techniques which, if not carefully followed, will result in damage to the equipment.

! WARNING: Procedures and techniques which, if not carefully followed, will expose the user to the risk of fire, serious injury, or death.

Welcome & Congratulations

Thank you and congratulations for purchasing an electric fireplace from Dimplex. Please use our convenient online registration page to record your model and serial numbers for future reference at

www.dimplex.com/register

Model and Serial
Number Label

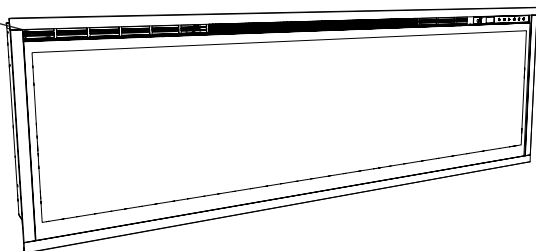

Please carefully read and save these instructions.

⚠ CAUTION: Read all instructions and warnings carefully before starting installation. Failure to follow these instructions may result in a possible electric shock, fire hazard and will void the warranty.



NO NEED TO RETURN TO THE STORE

Questions with operation or assembly? Require Parts Information?
Product Under Manufacturer's Warranty?

Contact us at:  **www.dimplex.com/customer_support**

For Troubleshooting and Technical Support

OR  **Toll-Free 1-888-DIMPLEX (1-888-346-7539)**

Monday to Friday 8:00 a.m. to 4:30 p.m. EST

In order to better serve you, please have your model and serial number ready or register your product online before calling (See above)

IMPORTANT INSTRUCTIONS

When using electrical appliances, basic precautions should always be followed to reduce the risk of fire, electric shock, and injury to persons, including the following:

- ① Read all instructions before installing or using this electric fireplace.
- ② This fireplace is hot when in use. To avoid burns, do not let bare skin touch hot surfaces. The trim around the heater outlet becomes hot during heater operation.
-  DANGER:** High temperatures may be generated under certain abnormal conditions. Do not partially or fully cover or obstruct the front of this heater.
- ③ Extreme caution is necessary when any heater is used by or near children or invalids and whenever the unit is left operating and unattended.
- ④ Young children should be supervised to ensure that they do not play with the appliance.
- ⑤ The appliance is not intended for use by young children or infirmed persons without supervision.

- ⑥ Do not operate the unit after it malfunctions. Disconnect power at the service panel and contact Dimplex Technical Service for service 1-888-346-7539.
- ⑦ Do not use outdoors.
- ⑧ Never locate fireplace where it may fall into a bathtub or other water container.
- ⑨ To disconnect the fireplace, turn the controls off, then disconnect the circuit at the main disconnect panel.
- ⑩ Do not locate the heater immediately below a fixed socket-outlet.
- ⑪ Do not insert or allow foreign objects to enter any ventilation or exhaust opening as this may cause an electric shock or fire, or damage to the heater.
- ⑫ To prevent a possible fire, do not block air intakes or exhaust in any manner.
- ⑬ All electrical heaters have hot and arcing or sparking parts inside. Do not use in areas where gasoline, paint, or flammable liquids are used or stored.

IMPORTANT INSTRUCTIONS

⑭ Use this heater only as described in this manual. Any other use not recommended by the manufacturer may cause fire, electric shock or injury to persons.

⑮ Do not burn wood or other materials in the electric fireplace.

⑯ Do not strike the fireplace glass.

⑰ Always use a certified electrician should new circuits be required.

⑱ Disconnect all power supply before performing any cleaning, maintenance or relocation of the unit.

⑲ When transporting or storing the unit and cord, keep in a dry place, free from excessive vibration and store so as to avoid damage.

 **WARNING:** Remote control contains small batteries. Keep away from children. If swallowed, seek medical attention immediately.

 **WARNING:** Do not install battery backwards, charge, put in fire or mix with used or other battery types - may explode or leak causing injury.

! NOTE: Changes or modifications not expressly approved by the party responsible for compliance could void user's authority to operate the equipment.



CAUTION
RISK OF ELECTRIC SHOCK
DO NOT OPEN
NO USER-SERVICABLE PARTS INSIDE



SAVE THESE INSTRUCTIONS



Quick Reference Guide

1. The electrical information regarding your electric fireplace can be found on the rating label located on the top of the unit.
Please use our convenient online registration page to record your model and serial numbers for future reference at www.dimplex.com/register
2. If you have any technical questions or concerns regarding the operation of your electric fireplace, or require service contact customer service at 1-888-346-7539.
3. For dimensions of your fireplace, refer to Figure 1.

Figure 1

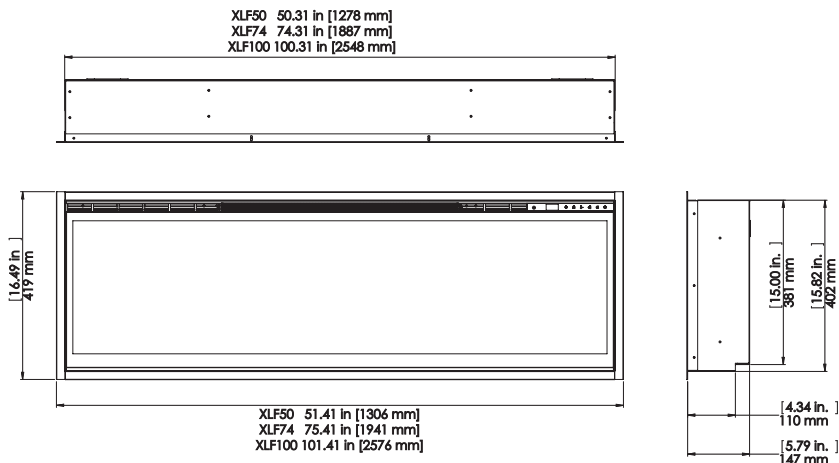

Fireplace Installation

⚠ CAUTION: Ensure installation does not allow fireplace to be in direct contact with building vapor barrier or insulation and meets all local building code.

! NOTE: A dedicated, properly fused 15 Amp circuit is required, rated for the appropriate voltage (120V, 240V).

⚠ WARNING: Construction and wiring must comply with local building codes and other applicable regulations to reduce the risk of fire, electric shock and injury to persons.

⚠ WARNING: To reduce the risk of fire, electric shock or injury to persons, always use a licensed electrician.

⚠ WARNING: To reduce the risk of fire, do not store or use gasoline or other flammable vapors or liquids in the vicinity of the heater.

1. Select a location that is not susceptible to moisture and is away from drapes, furniture and high traffic.

2. Unpack the fireplace and hardware from the box.

! NOTE: Leave the front

glass and partially reflective glass, safely, in the box until the time you are ready to install it.

3. Store the fireplace in a safe, dry and dust free location until you are ready to install the fireplace.

Installation

⚠ CAUTION: Two people will be required for various steps of this procedure.

This design of this unit allows three options for installation: **partial recess, flush mounted or sub-surface mounted.**

⚠ CAUTION: Sub-surface mounting should be limited

Figure 2

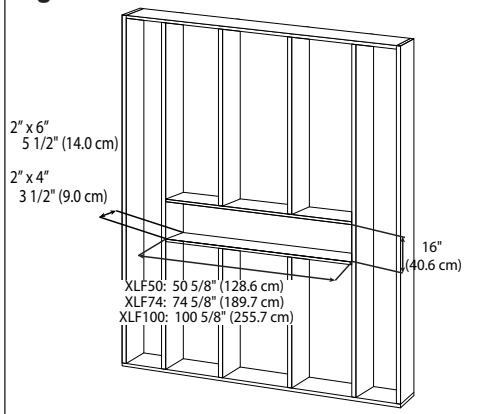

Fireplace Installation

to ½ in. (10 mm) to ensure adequate air flow of heated air out of the firebox area.

1. Prepare a wall with a framed opening of 16 in. (40.6 cm) high,
 - XLF50 - 50 ⅝ in. (128.7 cm)
 - XLF74 - 74 ⅝ in. (189.7 cm)
 - XLF100 - 100 ⅝ in. (255.7 cm) wide, with a bottom sill that is a **minimum** of 3.5 in. (9.0 cm) deep (figure 2). The sill can be constructed to support the front of the unit to allow the power supply wires to easily be run behind or flush with the back of the unit and a pass thru hole drilled for electrical wire routing.

! NOTE: It is recommended that the bottom of the unit be mounted

Figure 3

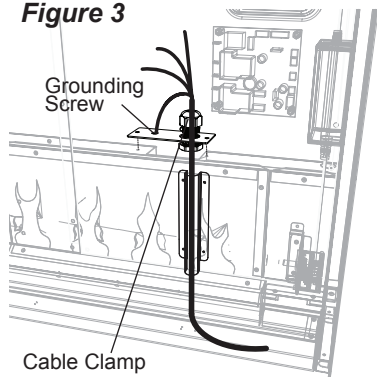

between 30 in. (76.2 cm) and 40 in. (102 cm) from the ground to maintain an optimized viewing angle of the flame.

⚠ WARNING: Do not attempt to wire your own new circuits. To reduce the risk of fire, electric shock or injury to persons, always use a licensed electrician.

⚠ WARNING: Ensure that the circuit on which the fireplace is to be installed has the power cut off at the service panel until installation is complete.

2. The unit is provided with an installed ¾ in. (2.0 cm) trim. Depending on the installation, this trim can be removed by removing the securing screws and the 4 trim pieces.
3. Ensuring a minimum of 18 in. (46.7 cm) of slack, route the supply power wire through a cable clamp (not included) and in the opening in the back of the unit. (Figure 3)
4. Lift fireplace, from the bottom and the handles located on the back, and insert into opening to the desired depth.
5. Using a bubble level (supplied) ensure that the fireplace is level within the framing. Adjust as

Fireplace Installation

Figure 4

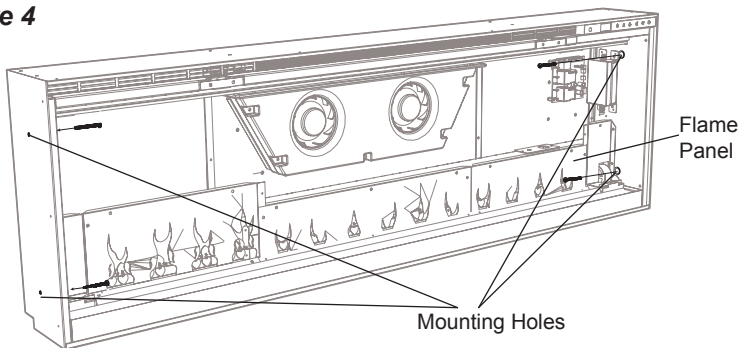

required.

6. Drive four supplied mounting screws through the four mounting holes located on the inside surface of the fireplace chassis, into wall studs (Figure 4).

120V Installation - Direct Wire

! NOTE: The unit is designed to be hardwired to a power source and should **not** have a cord installed to allow the unit to be plugged into a wall receptacle.

Use two conductor, non-metallic sheath cable with ground wire (3 wires total) for the incoming power supply.

⚠ CAUTION: Use the appropriate wire to meet local and national electrical codes for rated power consumption.

- Cut the wire to an appropriate length.
- Connect the L wire from the unit to the live wire from the power supply with a wire nut.
- Connect the N wire from the unit to the neutral wire from the power supply with a wire nut.
- Connect the G wire from the unit to the ground wire from the power supply with a wire nut **or** attach the grounding wire to the cover with the provided grounding screw, by placing the wire in-between screw and lock washer and tighten (Figure 3).
- Ensure that all wires are secure and do not protrude past the flame panel, so as not to be visible after final assembly.

Fireplace Installation

- Continue to the final assembly instructions.

120V Installation - Wall Switch

! NOTE: Use a single pole, single throw (On/Off) wall switch that is rated for a minimum of 15 amps.

! NOTE: The unit is designed to be hardwired to a power source and should **not** have a cord installed to allow the unit to be plugged into a wall receptacle.

Use two conductor, non-metallic sheath cable with ground wire (3 wires total) for the incoming power supply.

⚠ CAUTION: Use the appropriate wire to meet local and national electrical codes for rated power consumption.

- Cut the wire to an appropriate length.
- Connect the L wire from the unit to the live wire from the main power **through the wall switch**, ensuring all live connections are connected with a wire nut.
- Connect the N wire from the unit to the neutral wire from the power supply with a wire nut.
- Connect the G wire from the unit to the ground wire from the power supply with a wire nut **or** attach the grounding wire to the cover with the provided grounding screw, by placing the wire in-between screw and lock washer and tighten (Figure 3).
- Ensure that all wires are se-

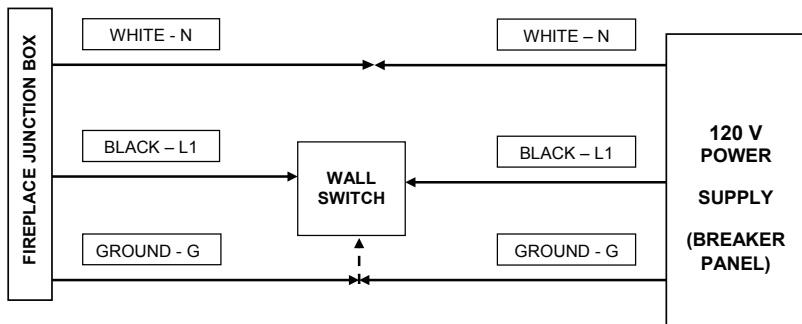

Fireplace Installation

Figure 6

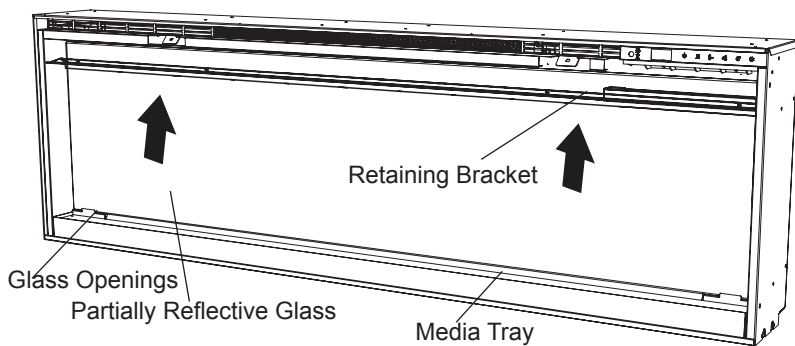

cure and do not protrude past the flame panel, so as not to be visible after final assembly.

- Continue to the final assembly instructions.

240V Installations

Use three conductor, non-metallic sheath cable with ground wire (4 wires total) for the incoming power supply on fireplace inserts.

⚠ CAUTION: Use the appropriate wire to meet local and national electrical codes for rated power consumption.

- Connect the L1 wire from the unit to the L1 wire from the power supply with a wire nut.
- Connect the L2 wire from the unit to the L2 wire from the

power supply with a wire nut.

- Connect the N wire from the unit to the neutral wire from the power supply.
- Connect the G wire from the unit to the ground wire from the power supply with a wire nut **or** attach the grounding wire to the cover with the provided grounding screw, by placing the wire in-between screw and lock washer and tighten (Figure 3).
- Ensure that all wires are secure and do not protrude past the flame panel, so as not to be visible after final assembly.
- Continue to the final assembly instructions.

Fireplace Installation

For Bathroom Use

If this unit is installed in a bathroom it must be protected by a GFI receptacle or circuit. If receptacle is used it must be readily accessible.

To prevent electrical shock this unit is an electrical appliance that is **NOT** watertight and must be installed as to prevent water from entering unit. This must be installed away from showers, tubs, etc. Never locate fireplace where it may fall into a bathtub or other water container.

Final Assembly

1. Locate and remove the 12 screws securing the partially reflective glass bracket to the unit, along the top of the opening, and set bracket and screws aside.
 2. Remove the provided suction cup from the inside cavity of the unit (only for XLF74 and XLF100 units).
 3. Before installation ensure that the front glass and the partially reflective glass are clean. Particles can be removed by dusting lightly with a clean dry cloth. To remove fingerprints or other marks, the glass can be cleaned with a damp cloth. Ensure that the glass has completely dried before installation.
 4. Carefully secure the suction cup to the partially reflective glass, reflective side out, and place into the openings on either side of the unit.
 5. Tip the glass into the unit and using the removed screws secure the glass into the unit with the provided bracket (Figure 6). Remove the suction cup.
 6. Evenly space the large media in the media tray along the back of the media tray (for optimum media effect), then carefully pour and evenly distribute the smaller media into the Media Tray.
 7. Carefully place the front glass into the lip located at the bottom of the opening of the firebox.
 8. Tip the front glass into the unit and secure using the provided screws and Allen key. (Figure 7).
- ! NOTE:** Ensure that the suction cup and Allen key are kept for any future maintenance or service.

🔧 Fireplace Installation

Figure 7

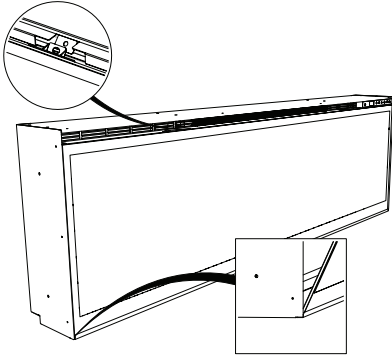

Wiring Diagram

XLF50

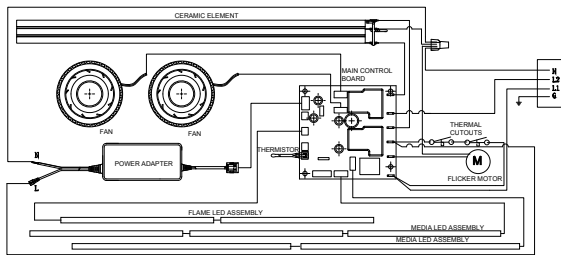

XLF74, XLF100

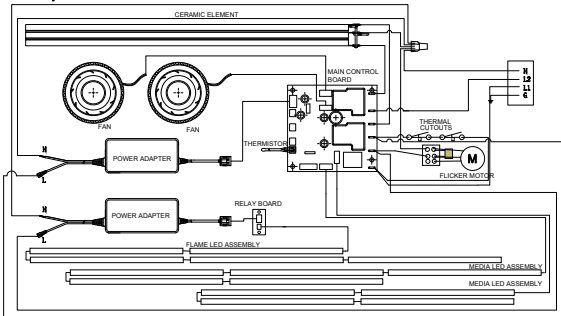

Operation

General Operation

⚠ WARNING: This electric firebox must be properly installed before it is used.

This firebox operates with ComfortSaver™ technology, which automatically adjusts the fan speed and heater wattage to safely and precisely match the requirements of the room based on the thermostat setting. The heater operates such that once the room reaches the set point, the fan and heater will continuously run at a low level, to maintain the desired room temperature. If the temperature in the room rises significantly, i.e. sun coming through a window or a central furnace turns on, the heater will turn off and periodically turn back on to circulate the air around the unit, until the room temperature drops and requires the heater to be constantly on again.

! NOTE: The unit is designed so that the fan will run continuously while the heater is on.

! NOTE: The element retains heat after shutdown, there is a built in cool down period of 2 minute before the fan shuts off completely, when the heat func-

tion is turned Off.

Remote Operation

The fireplace is supplied with an IR multi-function remote control.

! NOTE: To operate correctly, the remote control must be pointed towards the front of the unit.

Controls

The unit can be controlled by either the manual controls which are located on the upper right of the fireplace or the remote (Figure 8 & 8).

A. Standby

Turns the unit On and Off.

→ Activated by pressing the Standby button on the remote or the unit.

- The unit will turn On with the same functions that it was set to when it was turned Off and the intake temperature will be indicated on the Display.

! NOTE: When any button is pressed on the unit the intake temperature will be displayed on the Display for 7 seconds.

B. Flame Effects

Turns the Flame Effect On and Off.

🔑 Operation

Figure 8

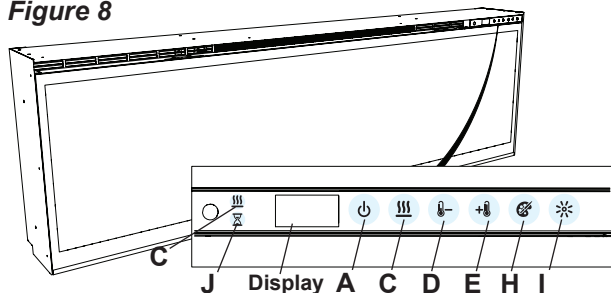

→ Activated by pressing the  button on the remote.

C. Heat ON/OFF

Turns the heater On and Off.

→ Activated by pressing the  button on the remote or the unit.

- Indicated by the  icon and the setpoint temperature will flash on the display, then the intake temperature will be displayed before turning off.

! NOTE: After the heater is switched off, there is a 2 minute fan delay, where the fan will continue running before turning off.

! NOTE: The unit can be operated in **Heat Only Mode**. When the unit is only running with the heater, the  icon will continuously be displayed on the Display.

! NOTE: The heater may emit

Figure 9

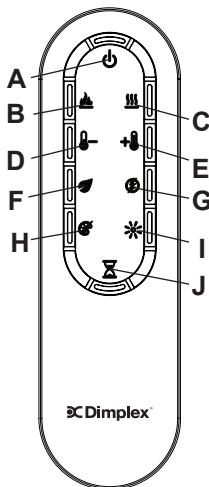

a slight, harmless odor when first used. This odor is a normal condition caused by initial heating of internal heater parts and will not occur again.

D. Temperature Down

Decreases the temperature setting.

→ Adjusted by repeatedly pressing the corresponding button on the remote.*

- Indicated by setpoint temperature on the Display decreasing and the speed of the fan decreasing to reduce the amount of heat being projected into the

Operation

room.**

E. Temperature Up



Increases the temperature setting.

→ Adjusted by repeatedly pressing the corresponding button on the remote.*

- Indicated by the setpoint on the Display increasing and the speed of the fan increasing to increase the amount of heat being projected into the room.

* The first time the button is pressed the current temperature set point will be displayed for 2 seconds.

** The temperature can be adjusted from 5 °C to 37 °C (41 °F to 99 °F).

! NOTE: Holding the  and the  buttons down for two seconds, on the unit, will change the temperature scale from °C to °F, or vice versa.

F. Eco Operation

Runs the heater in a reduced wattage range when activated.

→ Adjusted by pressing the corresponding button on the remote when the heater is on.

- Indicated by the Display and a reduced fan speed.

G. Heat Boost



Turns the Heater Boost On and Off. Runs the unit at the full rated wattage.

→ Activated and adjusted by repeatedly pressing the corresponding button on the remote.

- Indicated by the heater running at full heat, for a user set amount of time, to quickly heat up a cold room/space. The Heat Boost can be set for a maximum of 20 minutes, in 5 minute increments.

Disable Heat

If desired, depending on the season, the heater on the unit can be disabled. The function of the remaining controls will continue to function as outlined in this manual.

Pressing the  and  buttons on the unit at the same time and holding for 2 seconds will disable and enable the heater.

! NOTE: When the heater has been disabled and any of the heat related functions are used, the Display will indicate "---".

Operation

H. Color Themes

Different presets of lighting color combinations are available in the unit.

- Changed by repeatedly pressing the corresponding button on the remote or the unit.
- Cycles through the different preset light settings of the unit, this includes different combinations of colors of the flame base and media lighting.

! NOTE: Two of the themes in the cycle are a prism where the unit cycles through a variety of colors. Pressing the  stops the cycling and holds the unit on the preferred color, indicated by a solid circle. When the unit is on prism, and is cycling through the colors, a rotating circle will be displayed.

I. Brightness

Changes the Brightness of the lights in the unit.

- Adjusted by repeatedly pressing the corresponding button on the remote or the unit.
- Indicated by the second digit on the Display changing to show: "H" (high), and "L" (low).

J. Sleep Timer

The Sleep Timer can be set to automatically shut off the fireplace after a preset time (from 30 minutes to 8 hours).

- To set the timer press the timer button on the remote, repeatedly, until the desired time is displayed.
- The Display will display the different times as it is adjusted. Once the timer has begun, pressing the  button will display the time remaining before the unit turns Off.

! NOTE: The Sleep Timer can be cancelled at any time by pressing the  button repeatedly until the sleep timer displays nothing.

Resetting the Temperature Cutoff Switch

Should the heater overheat, an automatic cut out will turn the whole unit off and it will not come back on without being reset. If the  button on the unit is pressed, Er2 will be displayed on the unit. It can be reset by turning the unit off at the main disconnect panel and waiting 5 minutes before turn-

Operation

ing the unit back on.

⚠ CAUTION: If you need to continuously reset the heater, turn the unit off at the main disconnect panel and call technical support at 1-888-346-7539.

Remote Control Battery Replacement

To replace the Battery:

1. Slide battery cover open on the remote control.
2. Correctly install one 3 Volt (CR2032 [longer life] or CR2025) Battery in the battery holder.
3. Close the battery cover.



Battery must be recycled or disposed of properly. Check with your Local Authority or Retailer for recycling advice in your area



Maintenance

⚠ WARNING: Disconnect power and allow heater to cool before attempting any maintenance or cleaning to reduce the risk of fire, electric shock or damage to persons.

! NOTE: The fireplace should not be operated with an accumulation of dust or dirt on or in the unit, as this can cause a build up of heat and eventual damage. For this reason the heater must be inspected regularly, depending upon conditions and at a minimum yearly intervals.

Partially Reflective Glass Cleaning

The partially reflective glass is cleaned in the factory during the assembly operation. During shipment, installation, handling, etc., the partially reflective glass may collect dust particles; these can be removed by dusting lightly with a clean dry cloth.

To remove fingerprints or other marks, the partially reflective glass can be cleaned with a damp cloth. The partially reflective glass should be completely dried with a lint free cloth to prevent water spots. To prevent scratching, do

not use abrasive cleaners.

Fireplace Surface Cleaning

Use only a damp cloth to clean painted surfaces of the fireplace. Do not use abrasive cleaners.

Servicing

Except for installation and cleaning described in this manual, an authorized service representative should perform any other servicing.

Warranty

Products to which this limited warranty applies

This limited warranty applies to your newly purchased Dimplex electric fireplace. This limited warranty applies only to purchases made in any province of Canada except for Yukon Territory, Nunavut, or Northwest Territories or in any of the 50 States of the USA (and the District of Columbia) except for Hawaii and Alaska. This limited warranty applies to the original purchaser of the product only and is not transferable.

Products excluded from this limited warranty

Products purchased in Yukon Territory, Nunavut, Northwest Territories, Hawaii, or Alaska are not covered by this limited warranty. Products purchased in these States, provinces, or territories are sold AS IS without warranty or condition of any kind (including, without limitation, any implied warranties or conditions of merchantability or fitness for a particular purpose) and the entire risk of as to the quality and performance of the products is with the purchaser, and in the event of a defect the purchaser assumes the entire cost of all necessary servicing or repair.

What this limited warranty covers and for how long

Products, other than fireplace surrounds (mantels) and trims, covered by this limited warranty have been tested and inspected prior to shipment and, subject to the provisions of this warranty, Dimplex warrants such products to be free from defects in material and workmanship for a period of 2 years from the date of the first purchase of such products.

Dimplex fireplace surrounds (mantels) and trims covered by this limited warranty have been tested and inspected prior to shipment and, subject to the provisions of this warranty, Dimplex warrants such products to be free from defects in material and workmanship for a period of 1 year from the date of first purchase of such products.

The limited 2 year warranty period for products other than fireplace surrounds (mantels) and trims and the limited 1 year warranty period for fireplace surrounds (mantels) and trims also applies to any implied warranties that may exist under applicable law. Some jurisdictions do not allow limitations on how long an implied warranty lasts, so the above limitation may not apply to the purchaser.

What this limited warranty does not cover

This limited warranty does not apply to products that have been repaired (except by Dimplex or its authorized service representatives) or otherwise altered. This limited warranty does further not apply to defects resulting from misuse, abuse, accident, neglect, incorrect installation, improper maintenance or handling, or operation with an incorrect power source.

What you must do to get service under this limited warranty

Defects must be brought to the attention of Dimplex Technical Service by contacting Dimplex at 1-888-DIMPLEX (1-888-346-7539), or 1367 Industrial Road, Cambridge Ontario, Canada N3H 4W3. Please have proof of purchase, catalogue/model and serial numbers available when calling. Limited warranty service requires a proof of purchase of the product.

What Dimplex will do in the event of a defect

In the event a product or part covered by this limited warranty is proven to be defective in material or workmanship during (i) the 2 year limited warranty period for products other than fireplace surrounds (mantels) and trims, and (ii) the 1 year limited warranty period for surrounds (mantels) and trims, you have the following rights:

- Dimplex will in its sole discretion either repair or replace such defective product or part without charge. If Dimplex is unable to repair or replace such product or part, or if repair or replacement is



Warranty

not commercially practicable or cannot be timely made, Dimplex may, in lieu of repair or replacement, choose to refund the purchase price for such product or part.

- Limited warranty service will be performed solely by dealers or service agents of Dimplex authorized to provide limited warranty services.
- For products other than surrounds (mantels) and trims, this 2 year limited warranty entitles the purchaser to on-site or in-home warranty services. Accordingly, Dimplex will be responsible for all labour and transportation associated with repairing or replacing the product or part except as follows: (i) charges which may be levied for travel costs incurred to travel to the purchaser's site where the product is located if the purchaser's site is beyond 30 miles (48 km) from the closest service depot of Dimplex's dealer or service agent; and (ii) the purchaser is solely responsible for providing clear access to all serviceable parts of the product.
- For surrounds (mantels) and trims, this 1 year limited warranty does not entitle the purchaser to on-site or in-house warranty services. The purchaser is responsible for removal and transportation of the surrounds (mantels) and trims (and any repaired or replacement product or part) to and from the authorized dealer's or service agent's place of business. On-site or in-home services for surrounds (mantels) and trims may be performed at the purchaser's specific request and expense at Dimplex's then current rates for such services. Dimplex will not be responsible for, and this limited warranty shall not include, any expense incurred for installation or removal of the surrounds (mantels) or trims or any part thereof (or any replacement product or part) including, without limitation, all shipping costs and transportation costs to and from the authorized dealer's or service agent's

place of business and all labour costs. Such costs shall be the purchaser's responsibility.

What Dimplex and its dealers and service agents are also not responsible for.

IN NO EVENT WILL DIMPLEX, OR ITS DIRECTORS, OFFICERS, OR AGENTS, BE LIABLE TO THE PURCHASER OR ANY THIRD PARTY, WHETHER IN CONTRACT, IN TORT, OR ON ANY OTHER BASIS, FOR ANY INDIRECT, SPECIAL, PUNITIVE, EXEMPLARY, CONSEQUENTIAL, OR INCIDENTAL LOSS, COST, OR DAMAGE ARISING OUT OF OR IN CONNECTION WITH THE SALE, MAINTENANCE, USE, OR INABILITY TO USE THE PRODUCT, EVEN IF DIMPLEX OR ITS DIRECTORS, OFFICERS, OR AGENTS HAVE BEEN ADVISED OF THE POSSIBILITY OF SUCH LOSSES, COSTS OR DAMAGES, OR IF SUCH LOSSES, COSTS, OR DAMAGES ARE FORESEEABLE. IN NO EVENT WILL DIMPLEX, OR ITS OFFICERS, DIRECTORS, OR AGENTS BE LIABLE FOR ANY DIRECT LOSSES, COSTS, OR DAMAGES THAT EXCEED THE PURCHASE PRICE OF THE PRODUCT.

SOME JURISDICTIONS DO NOT ALLOW THE EXCLUSION OR LIMITATION OF INCIDENTAL OR CONSEQUENTIAL DAMAGES, SO THE ABOVE LIMITATION OR EXCLUSION MAY NOT APPLY TO THE PURCHASER.

How State and Provincial law apply

This limited warranty gives you specific legal rights, and you may also have other rights which vary from jurisdiction to jurisdiction. The provisions of the United Nations Convention on Contracts for the Sale of Goods shall not apply to this limited warranty or the sale of products covered by this limited warranty.



Technical Support

Technical and troubleshooting support, as well as a list of replacement parts can be found on

www.dimplex.com/customer_support.



Dimplex North America Limited

1367 Industrial Road
Cambridge ON
Canada N3H 4W3

© 2017 Dimplex North America Limited