

INSTALLATION INSTRUCTIONS

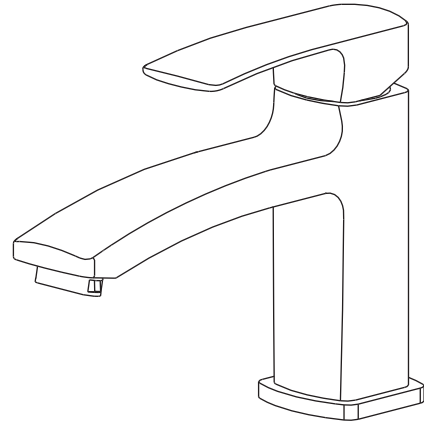

FFT3161CH Single-lever faucet



Important

We recommend that this product is installed by a qualified professional contractor.

- Please check this product immediately to ensure that it has not been damaged and is complete.
- Please flush the water system to ensure that no debris or any other impurities can enter the taps.
- Turn off water supply before commencing work.
- Please read these instructions carefully and keep for future reference.

Cleaning

Before use: Unscrew the Aerator and allow the water to run freely for 5 minutes. Then screw the filter back in place.

Periodically: Unscrew the Aerator and remove. Rinse it with running water until any loose debris is cleared. Then replace the Aerator and tighten.

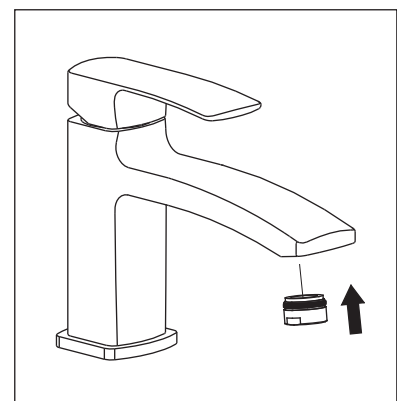
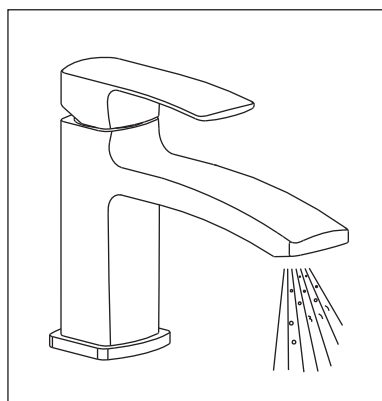
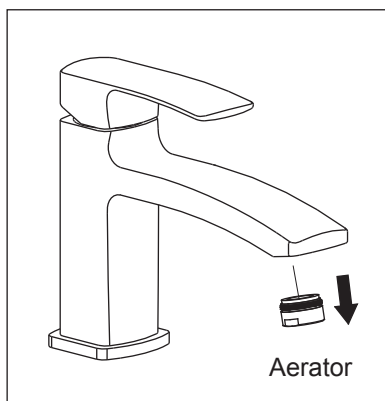

Maintenance

We do NOT recommend you use any household cleaners to clean the product. Because these cleaners change substance or formula too frequently. The product should always be cleaned with soapy water and rinsed with clean water and dried with a soft cloth.

Dimensions

Unit:inches

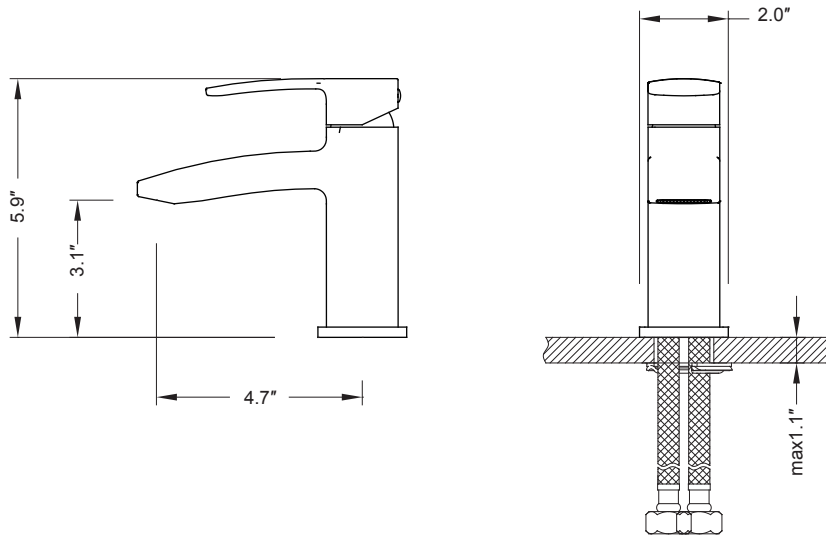

Installation

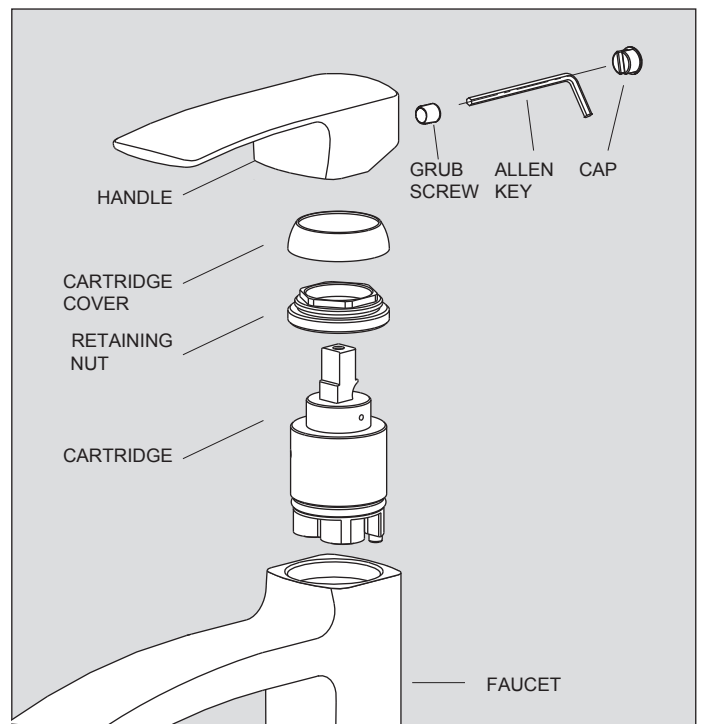
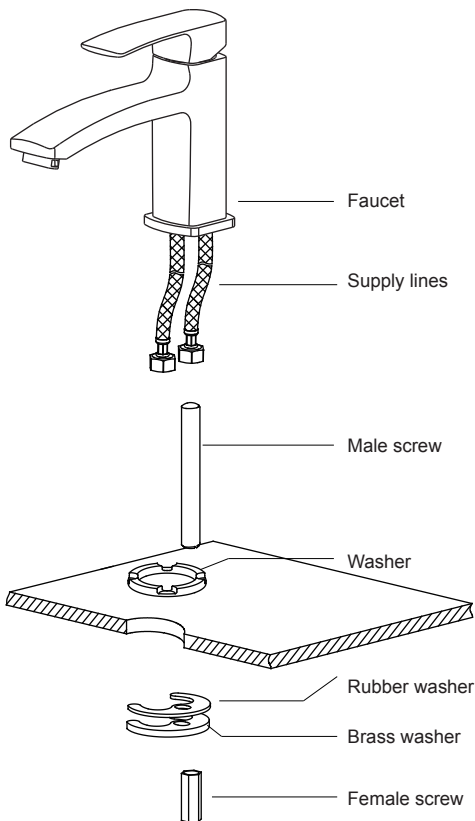

To remove the cartridge.

⚠ First shut off the water supply to the tap.

- 1: Pull out the cap from the handle.
- 2: Loosen the grub screw in handle, but do not remove it.
- 3: Take off the handle, unscrew the cartridge cover.
- 4: Unscrew the retaining nut.
- 5: Pull the cartridge and wash it with clean running water.
- 6: Dry and lightly grease the seals (only use silicone grease)

- 1: Twist supply lines into faucet. washer into the groove of faucet.
- 2: Pass supply lines through the countertop hole, fix the male screw to the faucet.
- 3: Pass the rubber washer and brass washer to the male screw, adjust the faucet and tighten the female screw.

