

JASON[®]

HYDROTHERAPY

8328 MacArthur Dr. • North Little Rock, AR 72118
 501.771.4477 • Fax: 501.771.2333
 Customer Service: 800.255.5766
 www.jasoninternational.com

forma[®] Collection Specifications

HE527

Whirlpool & Soaking

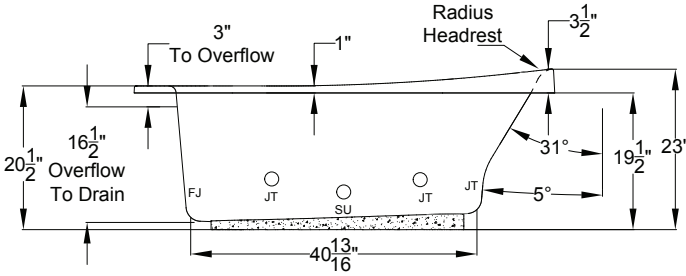
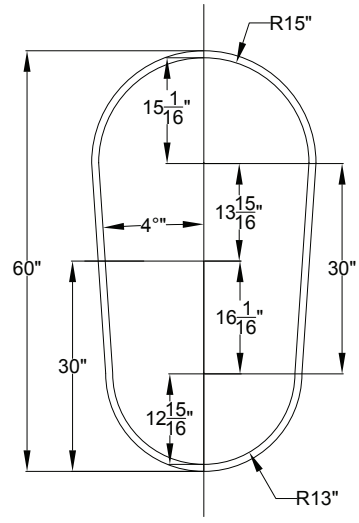
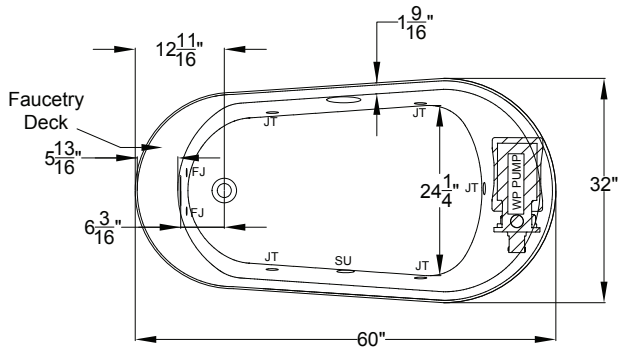

DROP IN HOLE SIZE

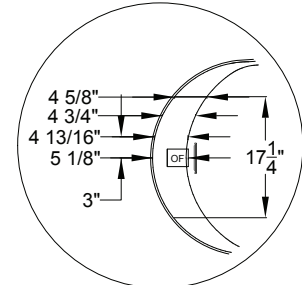



Faucet Deck Flat Dimensions

Patents received or pending.

Includes Linear Overflow Drain Assembly

Note: Dimensional Tolerances: ±1/4"

Drop-in-Hole Size:	See Diagram
Operating Capacity:	34 Gal.
Overflow Capacity:	71 Gal.
Floor Loading / sq.ft.	
(WP/Soaking):	55.2 / 51.7 lbs.
Carton Wt. (WP/Soaking):	102 / 68 lbs.
Cube:	33.7 ft. ³

Standard		A 120V system that includes a quiet 1-1/2 HP, 1-speed whirlpool pump, an electronic control, and a 20-minute timer. The keypad also operates the optional Jetted Neck Pillow.
Premier		A 120V system that includes a quiet 1-1/2 HP, 1-speed whirlpool pump, bath heater, (2) Chromatherapy mood lights, Automatic Ozone System, an electronic control, and a 20-minute timer. The keypad also operates the optional Jetted Neck Pillow.
Signature		A 120V system that includes a quiet 1-1/2 HP, 1-speed whirlpool pump, bath heater, (2) Chromatherapy mood lights, Automatic Ozone System, a digital control with LCD display, low water level and temperature sensors, a 20-minute timer, and Bluetooth Sound Immersion System. Control keypad operates the pump, LED Chromatherapy mood lights, optional Jetted Neck Pillow and shows equipment status, water temperature, and time remaining.

Construction: Fiberglass reinforced acrylic bath with Level Form™ full-support base.

We provide products listed with Intertek ETL SEMKO (Edison Testing Laboratories) U.S. and Canadian and with International Association of Plumbing and Mechanical Officials (IAPMO). Consult factory with your listing requirements.