

JASON[®]

HYDROTHERAPY

8328 MacArthur Dr. • North Little Rock, AR 72118
 501.771.4477 • Fax: 501.771.2333
 Customer Service: 800.255.5766
 www.jasoninternational.com

Integrity[®] Collection Specifications

S3060

AirMasseur[®]

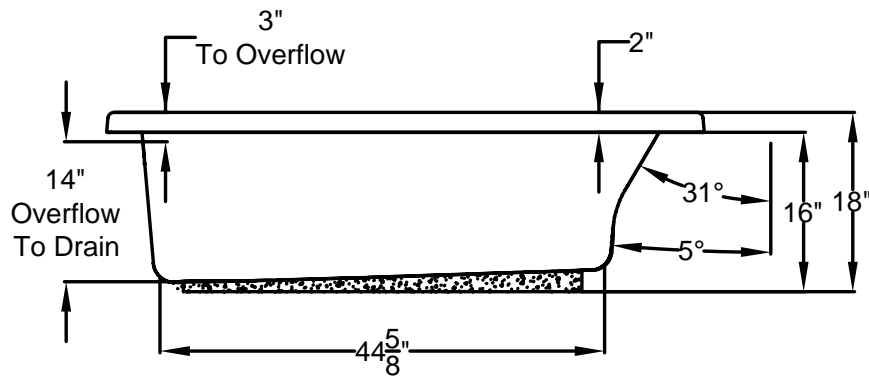
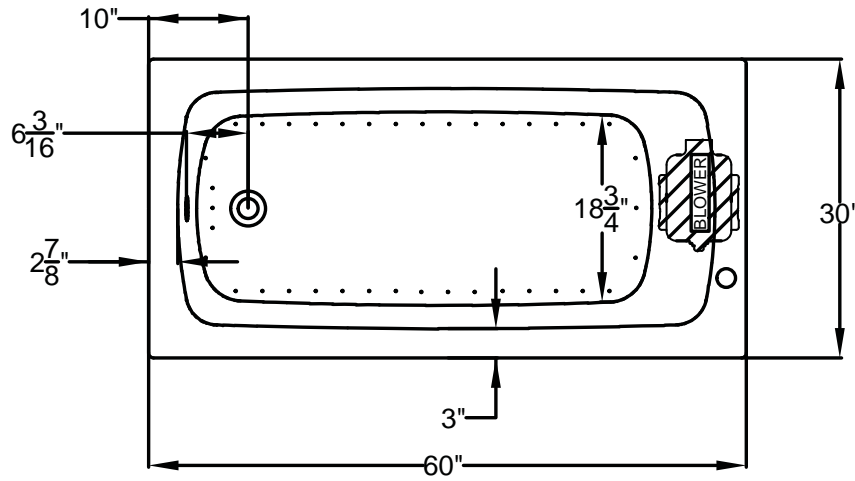

Patents received or pending.

Note: Dimensional Tolerances: ±1/4"

Drop-in-Hole Size:	28" x 58"
Operating Capacity:	24 Gal.
Overflow Capacity:	44 Gal.
Floor Loading / sq.ft.:	43.4 lbs.
Carton Weight:	84 lbs.
Cube:	22.4 ft. ³

Air Switch Control



Includes a quiet, 120v, 3/4 HP, variable speed air blower with an integral air heater, 20-minute timer and automatic purge cycle. Air switch operates the on/off and speed functions of the blower. Requires (1) 15A, 120v GFCI protected circuit.

Construction: Reinforced Acrylic shell mounted on Level Form™ pre-leveled full support base.

We provide products listed with Intertek ETL SEMKO (Edison Testing Laboratories) U.S. and Canadian and with International Association of Plumbing and Mechanical Officials (IAPMO). Consult factory with your listing requirements.