

Features

- Fits minimum 27-inch base cabinet if installed as top-mount or under-mount.
- Single bowl.
- 13-inch depth provides generous workspace.
- Three faucet holes.

Material

- KOHLER® enameled cast iron.

Installation

- Dual-mount sink can be installed as top-mount or under-mount.
- Under-mount installation kit not included.

Recommended Products/Accessories

K-8801 Sink Strainer
K-8799 Sink Strainer

Optional Products/Accessories

K-11352 Disposal Flange with Stopper
K-9000 P-Trap



Codes/Standards







ASME A112.19.1/CSA B45.2

KOHLER® Enameled Cast Iron Kitchen Sink Lifetime Limited Warranty

See website for detailed warranty information.

Available Colors/Finishes

Color tiles intended for reference only.

Color	Code	Description
	0	White
	FF	Sea Salt™
	96	Biscuit
	47	Almond
	95	Ice™ Grey
	7	Black Black™

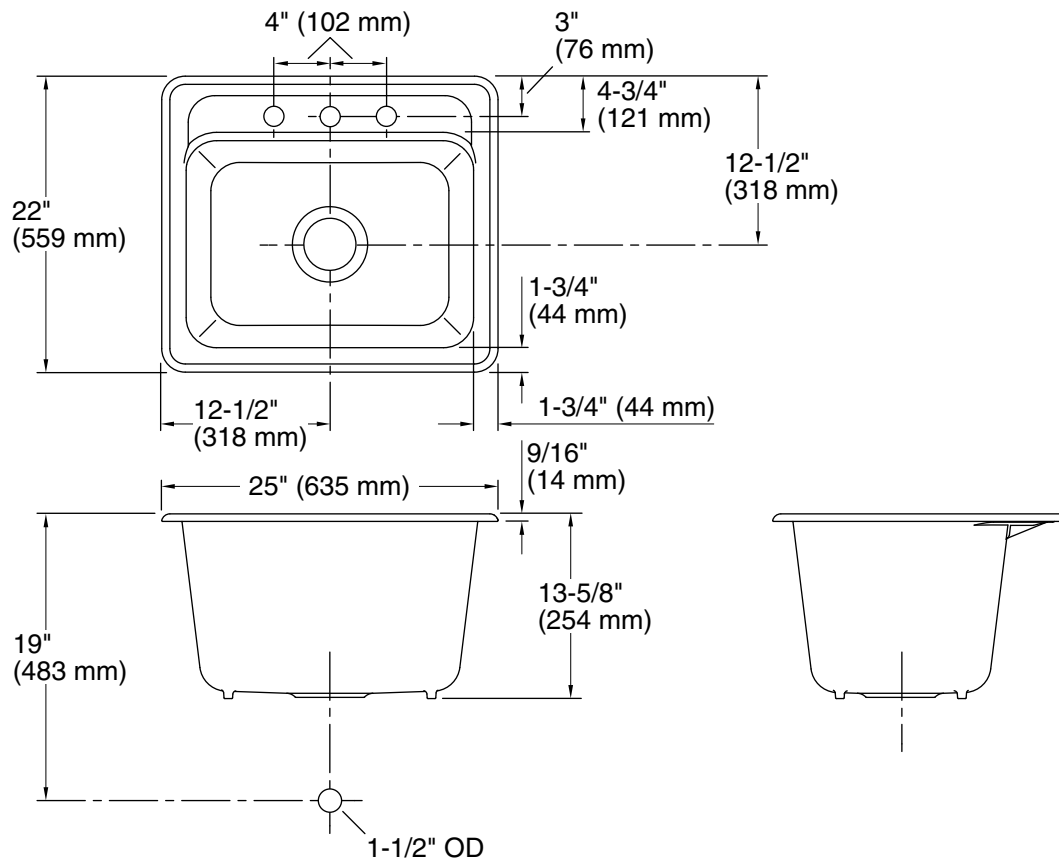

Technical Information

All product dimensions are nominal.

Bowl configuration:	Single
Installation:	Top-mount, Under-mount
Min. base cabinet width:	27" (686 mm)
Bowl area (Only):	Length: 21-1/2" (546 mm) Width: 15-1/2" (394 mm) Bowl depth: 13" (330 mm) Water depth: 13" (330 mm)
Number of deck holes:	3
Faucet hole(s):	1-3/8" (35 mm)
Drain hole:	3-7/8" (98 mm)
Template:	1079983-7, required, included

Notes

Install this product according to the installation instructions.