

### Features

- Fits minimum 21-inch base cabinet if installed as top-mount.
- Fits minimum 24-inch base cabinet if installed as under-mount.
- Single bowl.
- 12-1/2-inch depth provides generous workspace.
- Three faucet holes.
- Small size fits compact spaces.

### Material

- KOHLER® enameled cast iron.

### Installation

- Dual-mount sink can be installed as top-mount or under-mount.
- Under-mount installation kit not included.

### Recommended Products/Accessories

K-6021 Left-Bowl Sink Rack  
K-6022 Right-Bowl Sink Rack  
K-6129 Sink Rack  
K-6539 Drainboard with Sink Rack  
K-8801 Sink Strainer  
K-8799 Sink Strainer

### Optional Products/Accessories

K-11352 Disposal Flange with Stopper  
K-9000 P-Trap



### Codes/Standards







ASME A112.19.1/CSA B45.2

### KOHLER® Enameled Cast Iron Kitchen Sink Lifetime Limited Warranty

See website for detailed warranty information.

### Available Colors/Finishes

*Color tiles intended for reference only.*

Color	Code	Description
	0	White
	FF	Sea Salt™
	96	Biscuit
	47	Almond
	95	Ice™ Grey
	7	Black Black™

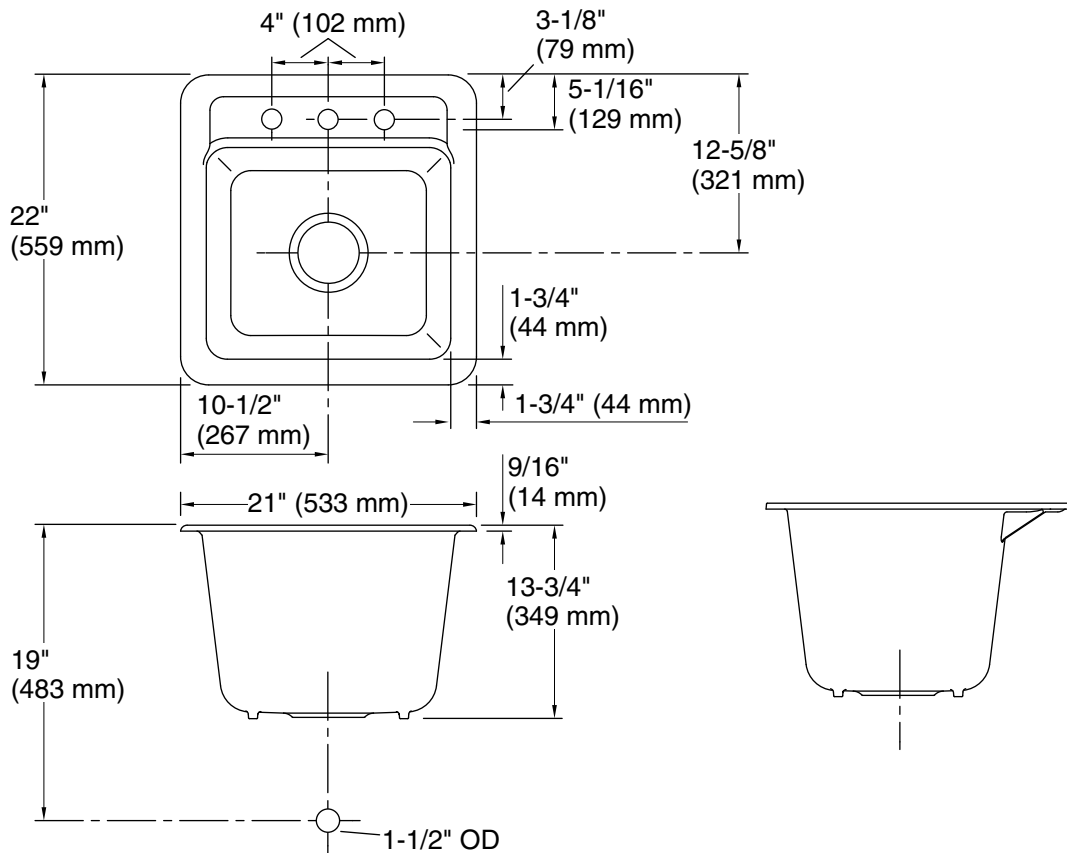

### Technical Information

All product dimensions are nominal.

Bowl configuration:	Single
Installation:	Top-mount, Under-mount
Min. base cabinet width:	24" (610 mm)
Bowl area (Only):	Length: 17-1/2" (445 mm) Width: 15-3/16" (386 mm) Bowl depth: 12-1/2" (318 mm) Water depth: 12-1/2" (318 mm)
Number of deck holes:	3
Faucet hole(s):	1-3/8" (35 mm)
Drain hole:	3-7/8" (98 mm)
Template:	1079985-7, required, included

### Notes

Install this product according to the installation instructions.