



# Iron Plains® Round

## Drop-In/Under-Mount Bathroom Sink

### K-20211

#### Features

- Small round basin.
- No faucet holes; requires wall- or counter-mount faucet.
- Overflow drain.

#### Material

- KOHLER® enameled cast iron.

#### Installation

- Drop-in or under-mount.

#### Included Components

Additional Components:

1193643 Basin clamps



**ADA** **CSA B651** **OBC**

#### Codes/Standards

ASME A112.19.1/CSA B45.2

ADA

ICC/ANSI A117.1

CSA B651











OBC

#### Lifetime Limited Warranty for KOHLER® Cast Iron Components

See website for detailed warranty information.

#### Available Colors/Finishes

*Color tiles intended for reference only.*

Color	Code	Description
	0	White
	FF	Sea Salt™
	96	Biscuit
	NY	Dune
	K4	Cashmere
	FT	Basalt
	KA	Black 'n Tan
	7	Black Black™
	GRL	Grey Lavender
	DGB	Indigo Blue
	PLM	Black Plum

1-800-4KOHLE (1-800-456-4537)

Kohler Co. reserves the right to make revisions without notice to product specifications.

For the most current Specification Sheet, go to [www.kohler.com](http://www.kohler.com).

12-24-2019 10:08 - US/CA

THE BOLD LOOK  
OF **KOHLER**®

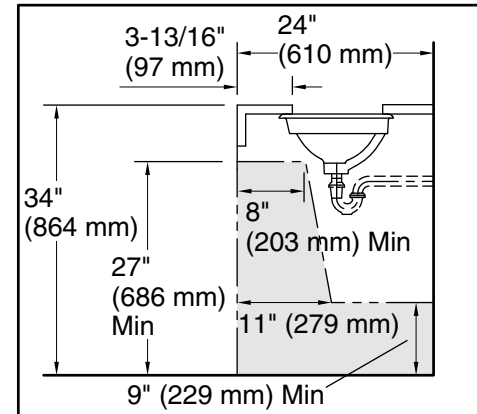
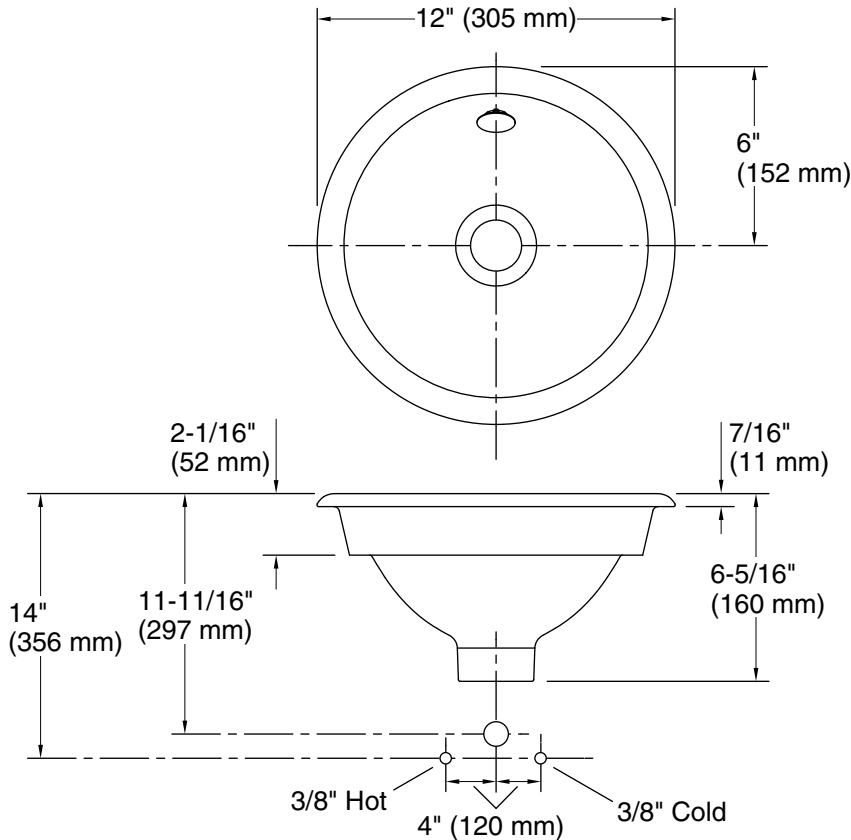

Recommended ADA Installation

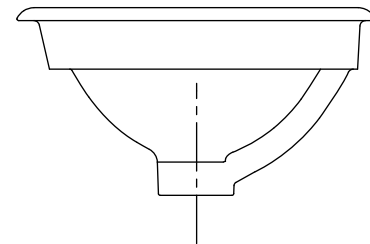

### Technical Information

All product dimensions are nominal.

Installation:	Drop-in, Under-mount
Bowl area:	Length: 10-13/16" (275 mm) Width: 10-13/16" (275 mm) Bowl depth: 4-1/2" (115 mm) Water depth: 3-1/16" (77 mm)
Drain hole:	1-3/4" (44 mm)
Template:	1319047-7, required, included

### Notes

Install this product according to the installation instructions.

Countertop manufacturer or cutter must use the cut-out template provided with the product, or a current one provided by Kohler Co. (call 1-800-43-FOCUS). Kohler Co. is not responsible for cut-out errors when the incorrect cut-out template is used.

ADA, OBC, CSA B651 compliant when installed to the specific requirements of these regulations.