

### Features

- Gently curved basin.
- Two side ledges.
- Overflow drain.
- No faucet holes; requires wall- or counter-mount faucet.

### Material

- KOHLER® enameled cast iron.

### Installation

- Under-mount.

### Recommended Products/Accessories

K-8998 P-Trap

### Included Components

Additional Components:

1193643 Basin clamps



ADA

CSA B651

### Codes/Standards

ASME A112.19.1/CSA B45.2

ADA

ICC/ANSI A117.1









CSA B651

### Lifetime Limited Warranty for KOHLER® Cast Iron Components

See website for detailed warranty information.

### Available Colors/Finishes

*Color tiles intended for reference only.*

Color	Code	Description
	0	White
	FF	Sea Salt™
	96	Biscuit
	47	Almond
	FD	Cane Sugar™
	KC	Vapour™ Blue
	KG	Vapour™ Green
	FT	Basalt
	KA	Black 'n Tan

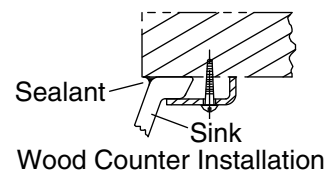
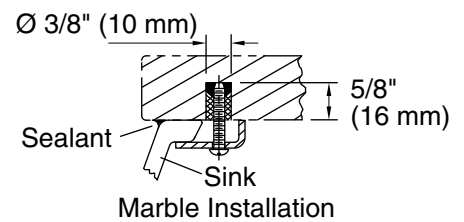
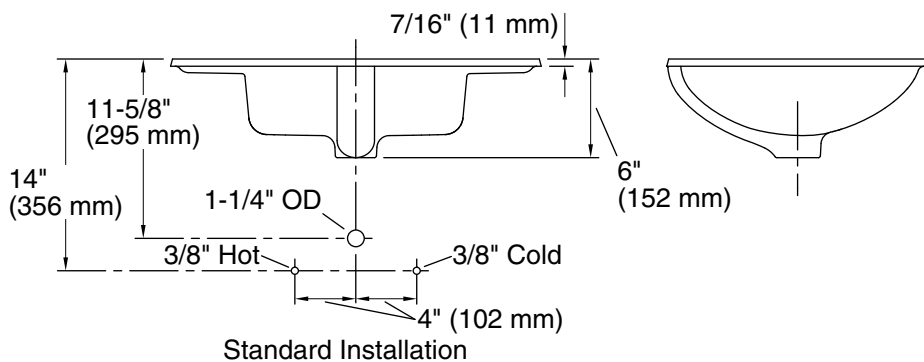
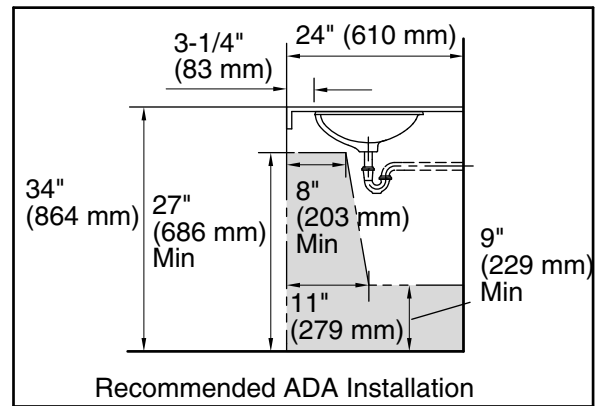
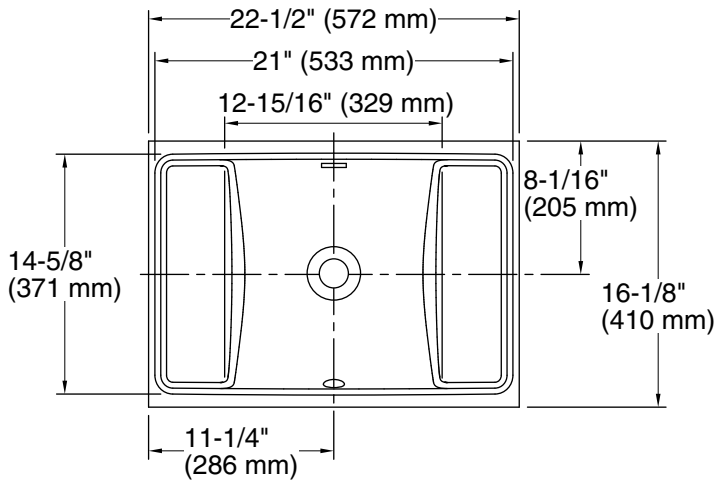

### Technical Information

All product dimensions are nominal.

- Bowl configuration: Single  
 Installation: Under-mount  
 Bowl area (Only): Length: 12-15/16" (329 mm)  
 Width: 14-5/8" (371 mm)  
 Water depth: 3-1/4" (83 mm)  
 Drain hole: 1-11/16" (43 mm)  
 Template: 1070407-7, required, included

### Notes

Install this product according to the installation instructions.

ADA, CSA B651 compliant when installed to the specific requirements of these regulations.