

Features

- 36-inch minimum base cabinet width.
- Single bowl.
- 9-inch depth.
- Self-Trimming apron overlaps the cabinet face for easy installation.
- Apron height allows sink to be used in most standard cabinetry or retrofitted to existing standard cabinetry.
- Single faucet hole.
- Rear drain increases workspace in the sink and storage space underneath.
- SilentShield® sound-absorption technology offers quieter performance.
- Includes installation hardware and compatibility template.

Material

- Handcrafted from 18-gauge stainless steel.
- Premium 18-gauge stainless steel.

Installation

- Top-mount apron-front.

Recommended Products/Accessories

- K-6474 Sink Rack
- K-8801 Sink Strainer
- K-8799 Sink Strainer

Optional Products/Accessories

- K-6429 Utility Rack
- K-11352 Disposal Flange with Stopper

Included Components

Product consists of:

- 1130570 Hardware Kit, Self-Rimming
- 1173293 Hardware Kit, Side Clip



Codes/Standards

ASME A112.19.3/CSA B45.4

Lifetime Limited Warranty for KOHLER® Stainless Steel Sinks

See website for detailed warranty information.

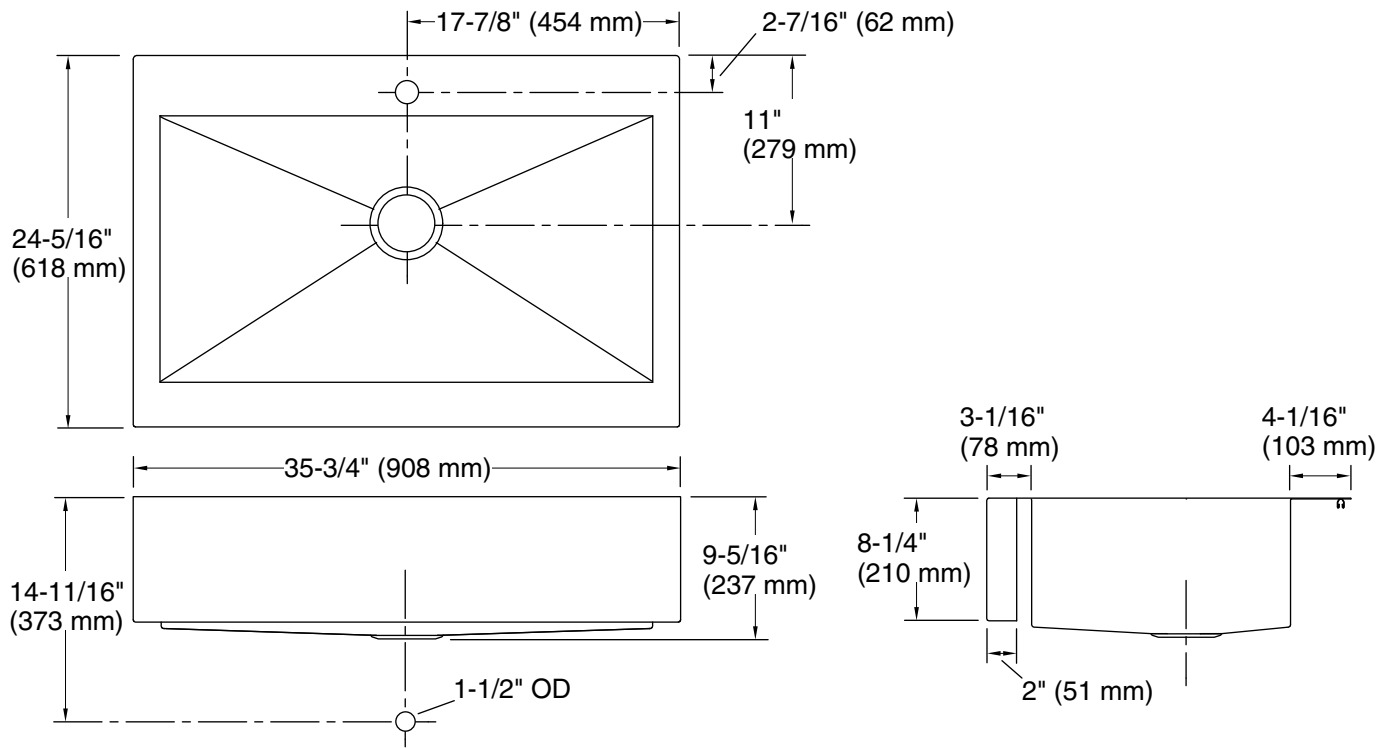

Technical Information

All product dimensions are nominal.

Bowl configuration:	Single
Installation:	Top-mount
Min. base cabinet width:	36" (914 mm)
Bowl area (Only):	Length: 32-1/2" (826 mm) Width: 17-3/16" (437 mm) Bowl depth: 9" (229 mm)
Number of deck holes:	1
Faucet hole(s):	1-7/16" (37 mm)
Drain hole:	3-5/8" (92 mm)
Template:	1166717-7, required, included 1178341, required, included

Notes

Install this product according to the installation instructions.

NOTICE: Countertop manufacturer or cutter must use the cut-out template provided with the product, or a current one provided by Kohler Co. (call 1-800-4-KOHLER). Kohler Co. is not responsible for cutout errors when the incorrect cut-out template is used.

IMPORTANT! The distance from the top edge of the cabinet to the top of the cabinet door must be at least 8-3/8" (213 mm) to install this sink.