



Iron/Tones®
 Top-/Under-Mount Kitchen Sink
K-5708

Features

- 30-inch minimum base cabinet width for top-mount installation.
- 33-inch minimum base cabinet width for under-mount.
- Single bowl.
- 9-inch depth.
- No faucet holes.

Material

- KOHLER® enameled cast iron.

Installation

- Top-mount or under-mount.

Recommended Products/Accessories

- K-8801 Sink Strainer
- K-8799 Sink Strainer

Optional Products/Accessories

- K-8343 Sink Rack
- K-11352 Disposal Flange with Stopper
- K-9000 P-Trap
- 1411886 Undermount kit 23 in.



Codes/Standards

ASME A112.19.1/CSA B45.2

KOHLER® Enameled Cast Iron Kitchen Sink Lifetime Limited Warranty

See website for detailed warranty information.

Available Colors/Finishes

Color tiles intended for reference only.

Color	Code	Description
	0	White
	FF	Sea Salt™
	96	Biscuit
	47	Almond
	FD	Cane Sugar™
	NY	Dune
	95	Ice™ Grey
	G9	Sandbar
	33	Mexican Sand™
	K4	Cashmere
	FT	Basalt
	58	Thunder™ Grey
	20	Suede
	KA	Black 'n Tan
	FP	Caviar
	7	Black Black™
	GRL	Grey Lavender
	DGB	Indigo Blue

1-800-4KOHLER (1-800-456-4537)

Kohler Co. reserves the right to make revisions without notice to product specifications.

For the most current Specification Sheet, go to www.kohler.com.

1-15-2020 05:31 - US/CA



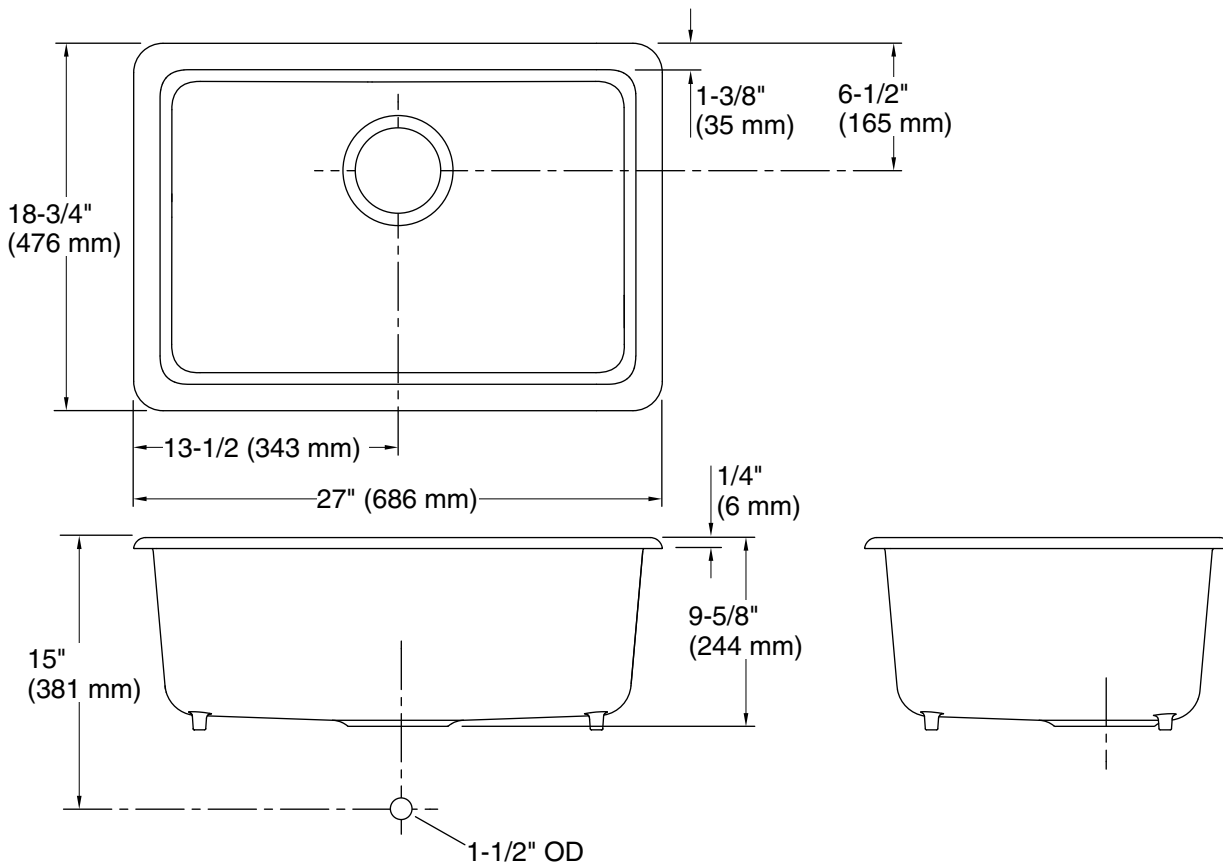

Technical Information

All product dimensions are nominal.

Installation:	Undermount, Top-mount
Min. base cabinet width:	33" (838 mm)
Bowl area (Only):	Length: 24-5/16" (617 mm) Width: 16-1/16" (408 mm) Bowl depth: 9" (229 mm) Water depth: 9" (229 mm)
Drain hole:	3-7/8" (98 mm)
Template:	1281370-7, required, included

Notes

Install this product according to the installation instructions.

Countertop manufacturer or cutter must use the cut-out template provided with the product, or a current one provided by Kohler Co. (call 1-800-43-FOCUS). Kohler Co. is not responsible for cut-out errors when the incorrect cut-out template is used.