

Features

- 36-inch minimum base cabinet width.
- Double equal bowls.
- 9-inch depth.
- Single faucet hole.
- Rear drain increases workspace in the sink and storage space underneath.

Material

- KOHLER® enameled cast iron.

Installation

- Top-mount.

Recommended Products/Accessories

- K-6539 Drainboard with Sink Rack
- K-5133 Left-Bowl Sink Rack
- K-5135 Right-Bowl Sink Rack
- K-8801 Sink Strainer
- K-8799 Sink Strainer

Optional Products/Accessories

- K-6016R Right-Bowl Sink Rack
- K-6545 Sponge Caddy
- 1054375 Undermount sink kit, 23"
- K-11352 Disposal Flange with Stopper
- K-9000 P-Trap



Codes/Standards









ASME A112.19.1/CSA B45.2

KOHLER® Enameled Cast Iron Kitchen Sink Lifetime Limited Warranty

See website for detailed warranty information.

Available Colors/Finishes

Color tiles intended for reference only.

Color	Code	Description
	0	White
	FF	Sea Salt™
	96	Biscuit
	47	Almond
	FD	Cane Sugar™
	95	Ice™ Grey
	K4	Cashmere
	7	Black Black™

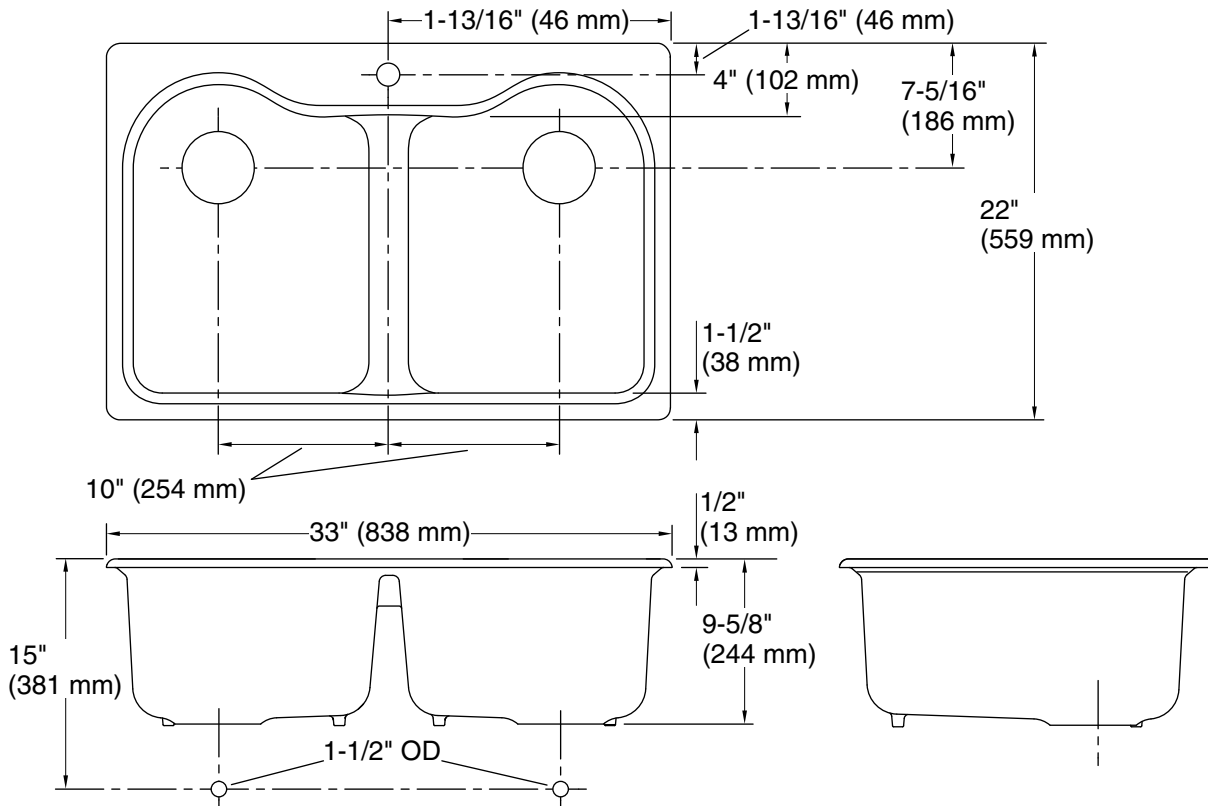

Technical Information

All product dimensions are nominal.

Bowl configuration:	Double equal
Installation:	Top-mount
Min. base cabinet width:	33" (838 mm)
Bowl area (Left):	Length: 14-1/8" (359 mm) Width: 16-1/4" (413 mm) Bowl depth: 9" (229 mm)
Bowl area (Right):	Length: 14-1/8" (359 mm) Width: 16-1/4" (413 mm) Bowl depth: 9" (229 mm)
Number of deck holes:	1
Faucet hole(s):	1-3/8" (35 mm)
Drain hole:	3-7/8" (98 mm)
Template:	1125670-7, required, included

Notes

Install this product according to the installation instructions.

NOTICE: The countertop manufacturer or cutter must use the cut-out template provided with the product, or a current one provided by the Kohler Co. (Call 1-800-4-KOHLER.) Kohler Co. is not responsible for cut-out errors when the incorrect cut-out template is used.