



# Brookfield™

## Top-mount Kitchen Sink

### K-5846-1

#### Features

- 33-inch minimum base cabinet width.
- Double equal bowls.
- 9-inch depth.
- Single faucet hole.
- Rear drain increases workspace in the sink and storage space underneath.
- Includes cutout template.

#### Material

- KOHLER® enameled cast iron.

#### Installation

- Top-mount.

#### Recommended Products/Accessories

- K-6197 Sink Rack
- K-8801 Sink Strainer
- K-8799 Sink Strainer

#### Optional Products/Accessories

- K-6545 Sponge Caddy
- K-11352 Disposal Flange with Stopper
- K-9000 P-Trap



#### Codes/Standards









ASME A112.19.1/CSA B45.2

#### KOHLER® Enameled Cast Iron Kitchen Sink Lifetime Limited Warranty

See website for detailed warranty information.

#### Available Colors/Finishes

*Color tiles intended for reference only.*

Color	Code	Description
	0	White
	FF	Sea Salt™
	96	Biscuit
	47	Almond
	FD	Cane Sugar™
	95	Ice™ Grey
	K4	Cashmere
	7	Black Black™

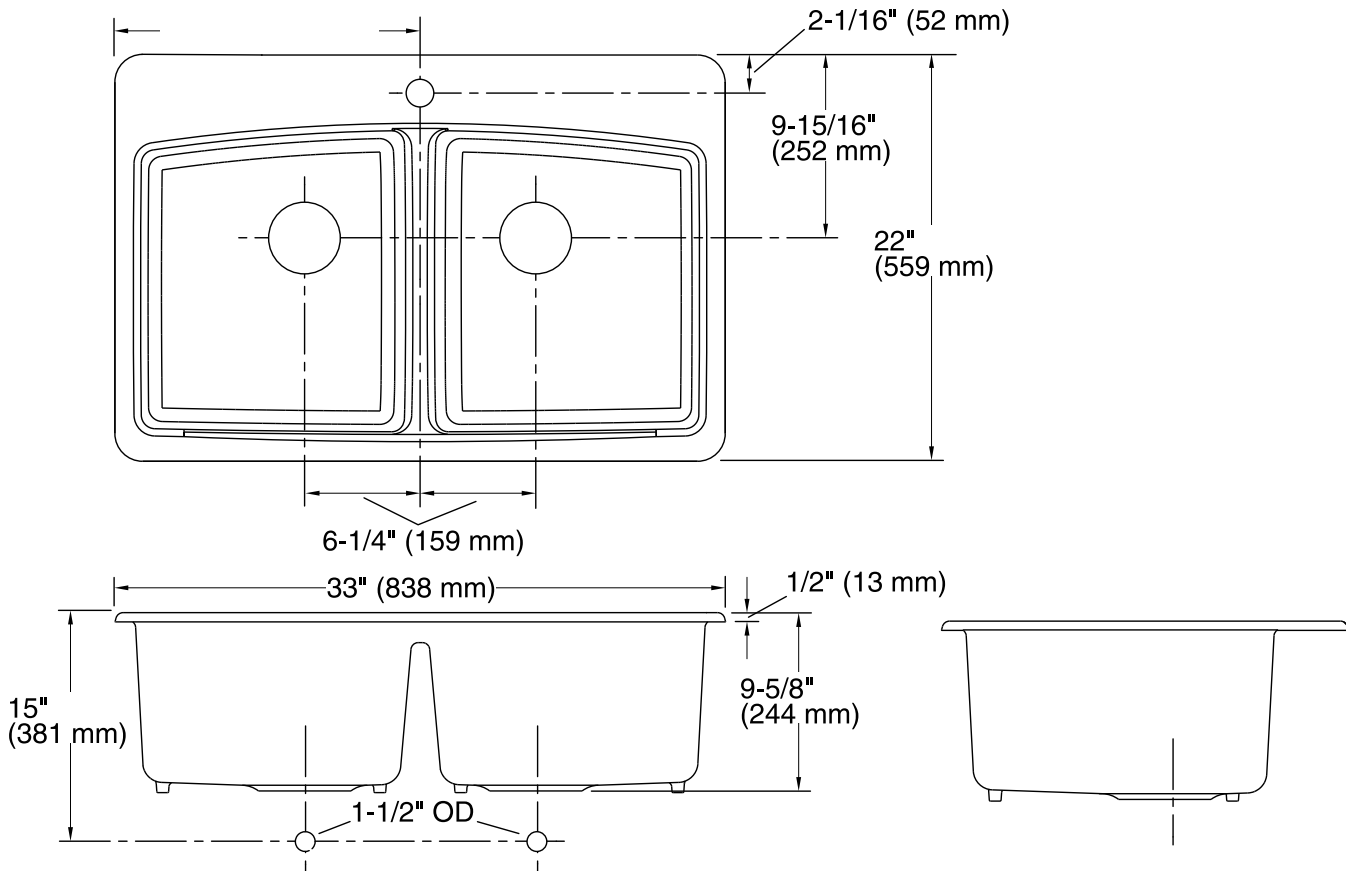

### Technical Information

All product dimensions are nominal.

Bowl configuration:	Double equal
Installation:	Top-mount
Min. base cabinet width:	33" (838 mm)
Bowl area (Left):	Length: 14-3/16" (360 mm) Width: 16-1/16" (408 mm) Bowl depth: 9" (229 mm)
Bowl area (Right):	Length: 14-3/16" (360 mm) Width: 16-1/16" (408 mm) Bowl depth: 9" (229 mm)
Number of deck holes:	1
Faucet hole(s):	1-3/8" (35 mm)
Drain hole:	3-7/8" (98 mm)
Template:	1174556-7, required, included

### Notes

Install this product according to the installation instructions.

**NOTICE:** Countertop manufacturer or cutter must use the cut-out template provided with the product, or a current one provided by Kohler Co. (call 1-800-4-KOHLER). Kohler Co. is not responsible for cutout errors when the incorrect cut-out template is used.