

Features

- 36-inch minimum base cabinet width.
- Large/medium bowls.
- 9-inch depth.
- Shortened apron allows sink to be used in most standard cabinetry or retrofitted to existing standard cabinetry.
- Self-Trimming apron overlaps the cabinet face for easy installation and beautiful results.
- No faucet holes.
- Smart Divide® features a low dividing barrier that increases workspace and versatility.
- Basin slopes toward drain to minimize water pooling.
- Offset drain increases workspace in the sink and storage space underneath.

Material

- KOHLER® enameled cast iron.

Installation

- Under-mount apron-front.

Recommended Products/Accessories

K-5828 Sink Rack
K-5874 Sink Rack
K-8801 Sink Strainer
K-8799 Sink Strainer

Optional Products/Accessories

K-11352 Disposal Flange with Stopper
K-9000 P-Trap

Included Components

Additional Components:

Cabinet face cut-out template
Countertop cut-out template



Codes/Standards



















ASME A112.19.1/CSA B45.2

KOHLER® Enameled Cast Iron Kitchen Sink Lifetime Limited Warranty

See website for detailed warranty information.

Available Colors/Finishes

Color tiles intended for reference only.

| Color | Code | Description |
|--|------|---------------|
|  | 0 | White |
|  | FF | Sea Salt™ |
|  | 96 | Biscuit |
|  | 47 | Almond |
|  | FD | Cane Sugar™ |
|  | NY | Dune |
|  | 95 | Ice™ Grey |
|  | G9 | Sandbar |
|  | 33 | Mexican Sand™ |
|  | K4 | Cashmere |
|  | FT | Basalt |
|  | 58 | Thunder™ Grey |
|  | 20 | Suede |
|  | KA | Black 'n Tan |
|  | FP | Caviar |
|  | 7 | Black Black™ |
|  | GRL | Grey Lavender |
|  | DGB | Indigo Blue |

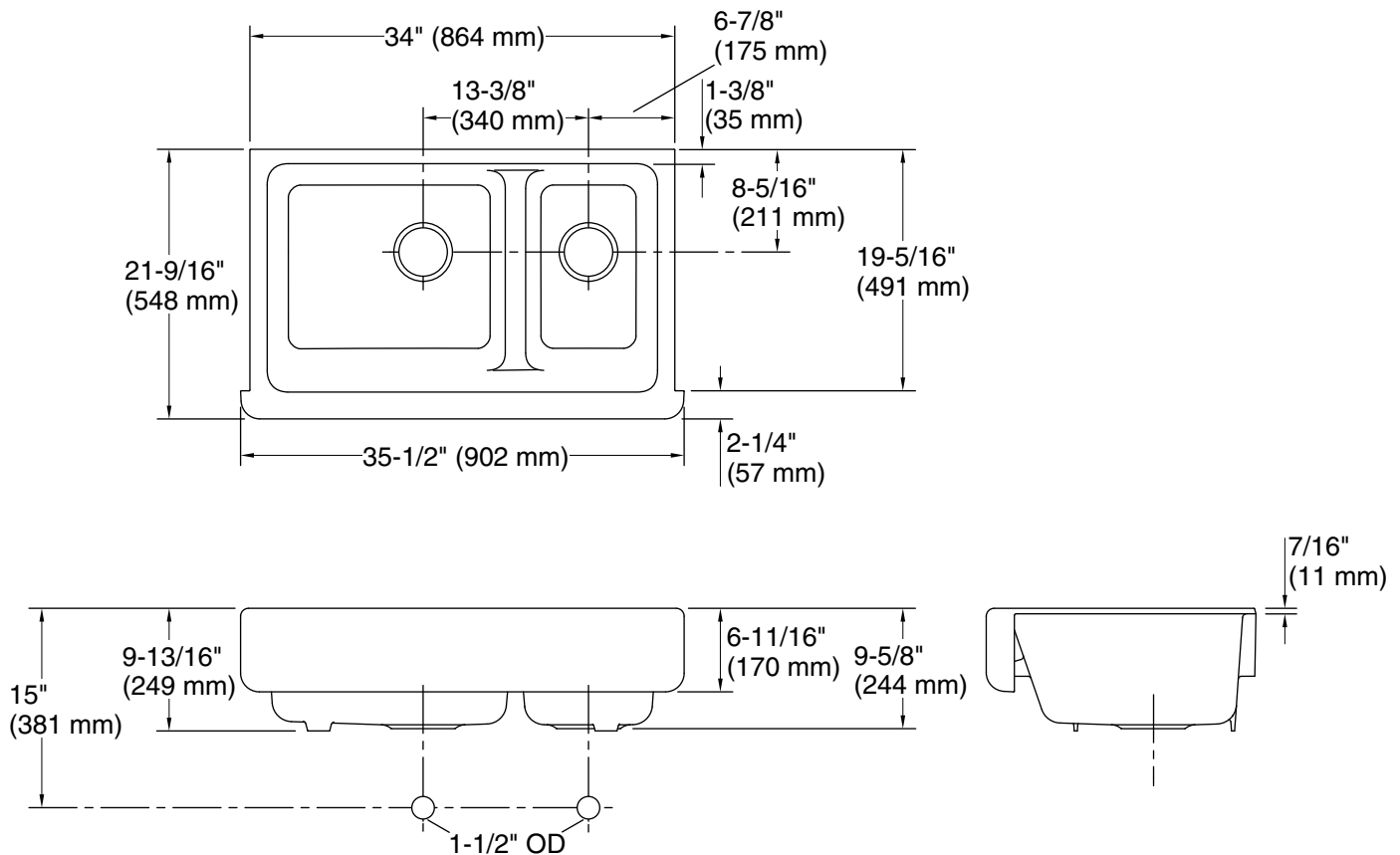

Technical Information

All product dimensions are nominal.

| | |
|--------------------------|---|
| Bowl configuration: | Off-set Large/small |
| Installation: | Under-mount |
| Min. base cabinet width: | 36" (914 mm) |
| Bowl area: | Length: 18-13/16" (478 mm) Width: 18-1/16" (459 mm) Bowl depth: 9" (229 mm) Water depth: 9" (229 mm) |
| Bowl area: | Length: 10-5/16" (262 mm) Width: 18-1/16" (459 mm) Bowl depth: 9" (229 mm) Water depth: 9" (229 mm) |
| Drain hole: | 3-5/8" (92 mm) |

Notes

Install this product according to the installation instructions.

NOTICE: The countertop manufacturer or cutter must use the cut-out template provided with the product, or a current one provided by Kohler Co. (call 1-800-4KOHLER). Kohler Co. is not responsible for cut-out errors when the incorrect cut-out template is used.

IMPORTANT! The distance from the top edge of the cabinet to the top of the cabinet door must be at least 6-7/8" (175 mm) to install this sink.