

Features

- 30-inch minimum base cabinet width.
- Single bowl.
- 9-inch depth.
- Five oversized faucet holes.
- Bowl slopes 2 degrees toward drain to minimize water pooling.
- Offset drain increases workspace in the sink and storage space underneath.
- Includes K-6239 colander with integral cutting board and K-9137 bottom sink rack.

Material

- KOHLER® enameled cast iron.

Installation

- Under-mount.

Recommended Products/Accessories

K-8801 Sink Strainer
K-8799 Sink Strainer

Optional Products/Accessories

K-11352 Disposal Flange with Stopper
K-9000 P-Trap
1411886 Undermount kit 23 in.

Included Components

Product consists of:

K-9137 Sink Rack
K-6239 Colander with Cutting Board



Codes/Standards



















ASME A112.19.1/CSA B45.2

KOHLER® Enameled Cast Iron Kitchen Sink Lifetime Limited Warranty

See website for detailed warranty information.

Available Colors/Finishes

Color tiles intended for reference only.

Color	Code	Description
	0	White
	FF	Sea Salt™
	96	Biscuit
	47	Almond
	FD	Cane Sugar™
	NY	Dune
	95	Ice™ Grey
	G9	Sandbar
	33	Mexican Sand™
	K4	Cashmere
	FT	Basalt
	58	Thunder™ Grey
	20	Suede
	KA	Black 'n Tan
	FP	Caviar
	7	Black Black™
	GRL	Grey Lavender
	DGB	Indigo Blue

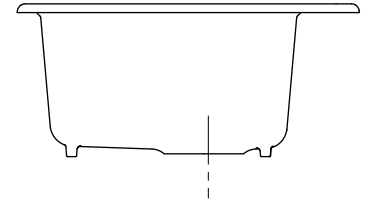
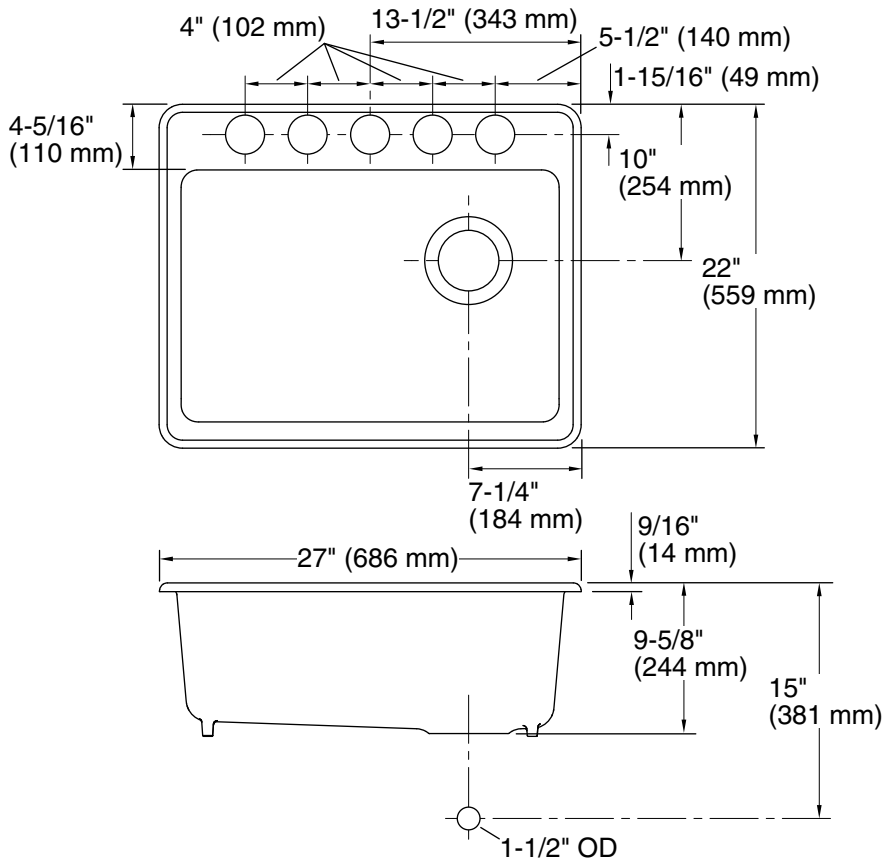

Technical Information

All product dimensions are nominal.

Bowl configuration:	Single
Installation:	Undermount
Min. base cabinet width:	30" (762 mm)
Bowl area:	Length: 24-1/4" (616 mm) Width: 17-1/4" (438 mm) Bowl depth: 9" (229 mm) Water depth: 9" (229 mm)
Number of deck holes:	5
Drain hole:	3-7/8" (98 mm)
Template:	1244382-7, required, included

Notes

Install this product according to the installation instructions.