

### Features

- 33-inch minimum base cabinet width.
- Large/medium bowls.
- 9-inch depth.
- Three faucet holes.
- Bowl slopes 2 degrees toward drain to minimize water pooling.
- Offset drains increase workspace in the sink and storage space underneath.
- Includes K-6239 colander with integral cutting board and K-9234 left-hand bottom sink rack.

### Material

- KOHLER® enameled cast iron.

### Installation

- Top-mount.

### Recommended Products/Accessories

- K-9234 Left-Bowl Sink Rack
- K-8801 Sink Strainer
- K-8799 Sink Strainer

### Optional Products/Accessories

- K-11352 Disposal Flange with Stopper
- K-9000 P-Trap

### Included Components

Product consists of:

- K-9234 Left-Bowl Sink Rack
- K-6239 Colander with Cutting Board



### Codes/Standards











ASME A112.19.1/CSA B45.2

### KOHLER® Enameled Cast Iron Kitchen Sink Lifetime Limited Warranty

See website for detailed warranty information.

### Available Colors/Finishes

*Color tiles intended for reference only.*

Color	Code	Description
	0	White
	FF	Sea Salt™
	96	Biscuit
	47	Almond
	FD	Cane Sugar™
	95	Ice™ Grey
	G9	Sandbar
	K4	Cashmere
	20	Suede
	KA	Black 'n Tan
	7	Black Black™

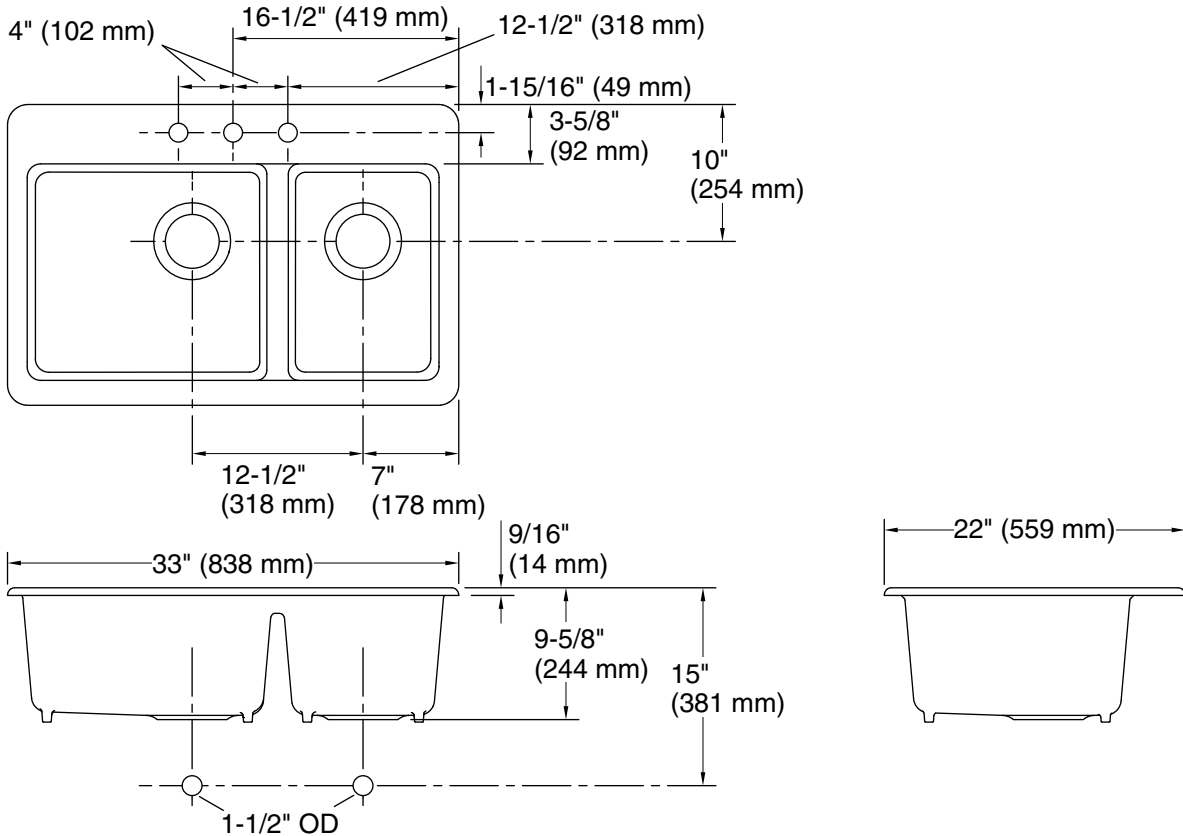

## Technical Information

All product dimensions are nominal.

Installation:	Top-mount
Min. base cabinet width:	33" (838 mm)
Bowl area (Left):	Length: 17-9/16" (446 mm) Width: 17-1/4" (438 mm) Bowl depth: 9" (229 mm) Water depth: 9" (229 mm)
Bowl area (Right):	Length: 11-1/16" (281 mm) Width: 17-1/4" (438 mm) Bowl depth: 9" (229 mm) Water depth: 9" (229 mm)
Number of deck holes:	3
Template:	1166727-7, required, included

## Notes

Install this product according to the installation instructions.