

Features

- 33-inch minimum base cabinet width.
- Large/medium bowls.
- 9-inch depth.
- Three faucet holes with one accessory hole to the right.
- Bowl slopes 2 degrees toward drain to minimize water pooling.
- Offset drains increase workspace in the sink and storage space underneath.
- Includes K-6239 colander with integral cutting board and K-9234 left-hand bottom sink rack.

Material

- KOHLER® enameled cast iron.

Installation

- Top-mount.

Recommended Products/Accessories

- K-9234 Left-Bowl Sink Rack
- K-8801 Sink Strainer
- K-8799 Sink Strainer

Optional Products/Accessories

- K-11352 Disposal Flange with Stopper
- K-9000 P-Trap

Included Components

Product consists of:

- K-9234 Left-Bowl Sink Rack
- K-6239 Colander with Cutting Board



Codes/Standards











ASME A112.19.1/CSA B45.2

KOHLER® Enameled Cast Iron Kitchen Sink Lifetime Limited Warranty

See website for detailed warranty information.

Available Colors/Finishes

Color tiles intended for reference only.

Color	Code	Description
	0	White
	FF	Sea Salt™
	96	Biscuit
	47	Almond
	FD	Cane Sugar™
	95	Ice™ Grey
	G9	Sandbar
	K4	Cashmere
	20	Suede
	KA	Black 'n Tan
	7	Black Black™

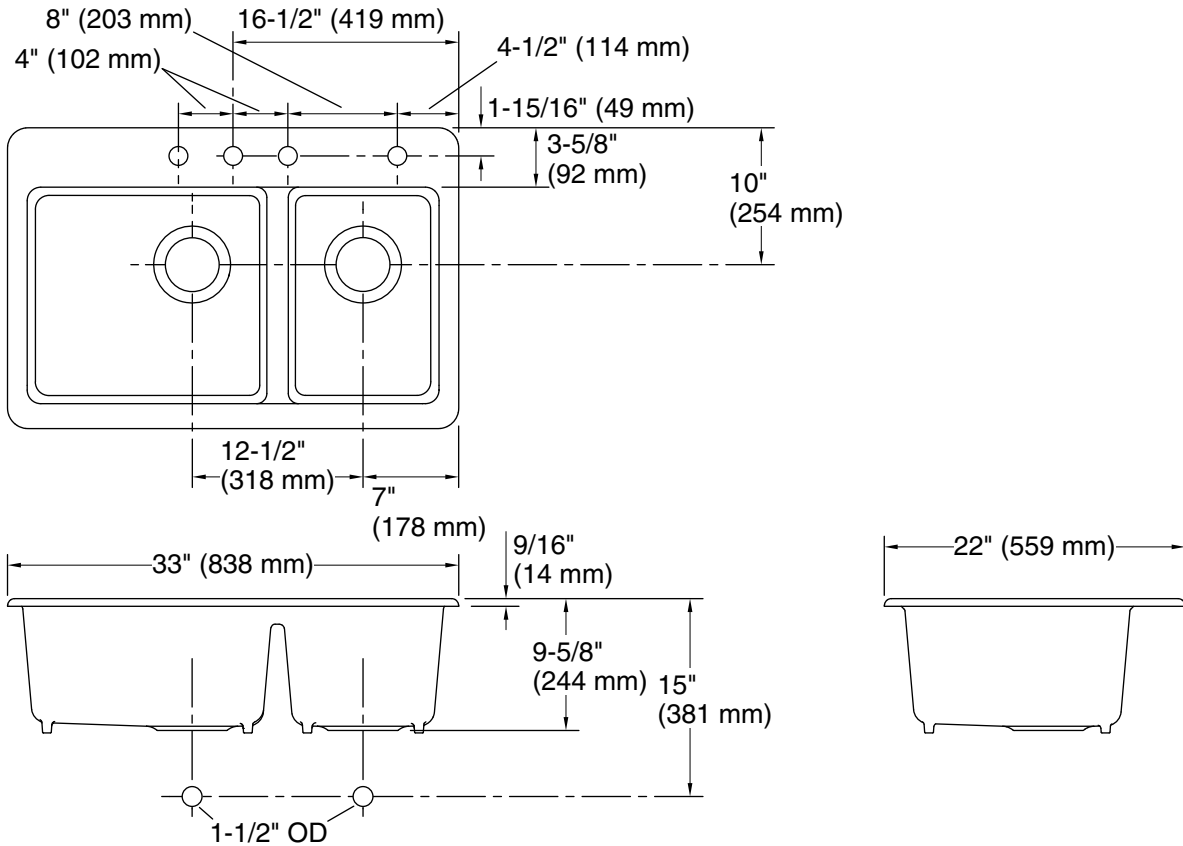

Technical Information

All product dimensions are nominal.

- Installation: Top-mount
- Min. base cabinet width: 33" (838 mm)
- Bowl area (Left):
 - Length: 17-9/16" (446 mm)
 - Width: 17-1/4" (438 mm)
 - Bowl depth: 9" (229 mm)
 - Water depth: 9" (229 mm)
- Bowl area (Right):
 - Length: 11-1/16" (281 mm)
 - Width: 17-1/4" (438 mm)
 - Bowl depth: 9" (229 mm)
 - Water depth: 9" (229 mm)
- Number of deck holes: 4
- Faucet hole spacing: 4" (102 mm)
- Template: 1166727-7, required, included

Notes

Install this product according to the installation instructions.