

### Features

- 36-inch minimum base cabinet width.
- Single bowl.
- 5-1/4-inch depth.
- Three faucet holes with one accessory hole to the right.
- Bowl slopes 2 degrees toward drain to minimize water pooling.
- Offset drain increases workspace in the sink and storage space underneath.

### Material

- KOHLER® enameled cast iron.

### Installation

- Top-mount.

### Recommended Products/Accessories

- K-6237 Left-Bowl Sink Rack
- K-6255 Right-Bowl Sink Rack
- K-8801 Sink Strainer
- K-8799 Sink Strainer

### Optional Products/Accessories

- K-11352 Disposal Flange with Stopper
- K-9000 P-Trap



ADA

### Codes/Standards











ASME A112.19.1/CSA B45.2  
ADA  
ICC/ANSI A117.1

### KOHLER® Enameled Cast Iron Kitchen Sink Lifetime Limited Warranty

See website for detailed warranty information.

### Available Colors/Finishes

*Color tiles intended for reference only.*

Color	Code	Description
	0	White
	FF	Sea Salt™
	96	Biscuit
	47	Almond
	FD	Cane Sugar™
	95	Ice™ Grey
	G9	Sandbar
	K4	Cashmere
	KA	Black 'n Tan
	7	Black Black™

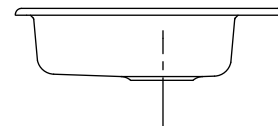
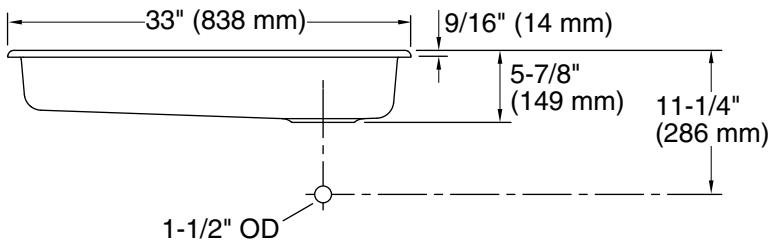
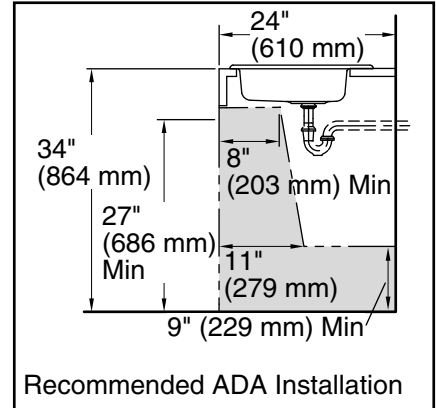
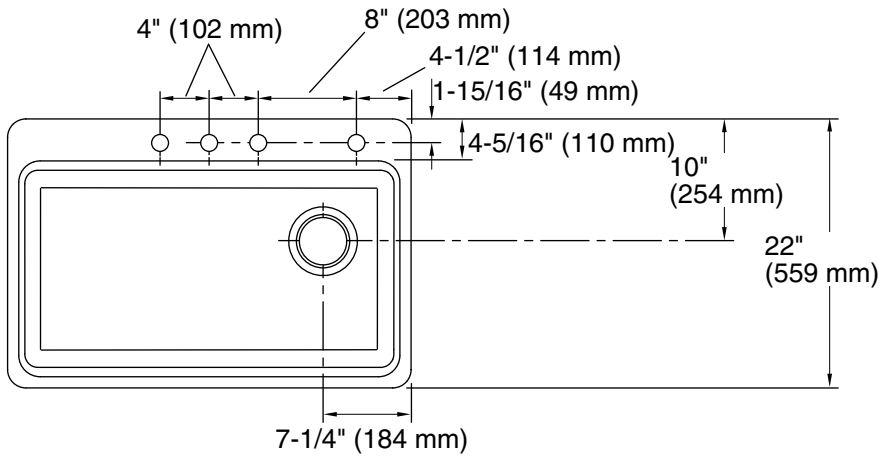

### Technical Information

All product dimensions are nominal.

- Bowl configuration: Single
- Installation: Top-mount
- Min. base cabinet width: 33" (838 mm)
- Bowl area (Only):
  - Length: 30-1/4" (769 mm)
  - Width: 17-1/4" (438 mm)
  - Bowl depth: 5-1/4" (133 mm)
  - Water depth: 5-1/4" (133 mm)
- Faucet hole spacing: 4" (102 mm)
- Template: 1166727-7, required, included

### Notes

- Install this product according to the installation instructions.
- ADA compliant when installed to the specific requirements of these regulations.