

■ Order by Part Number

M•POWER®
Transitional Style
Electronic Soap Dispenser

MODEL	FINISH
8558	Chrome

Spacer, Gasket, and
 Mounting Stud
 (For use with top mounted
 sink lip heights up to
 approximately 13/16 in.)

181148

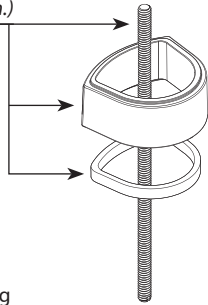

Soap Vandal Sheathing
 (Soap Tube not included)

182419

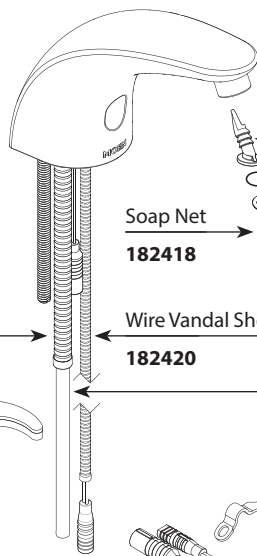

Soap Net
182418

Wire Vandal Sheathing
182420

Mounting Hardware

146190

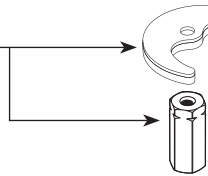

Mounting Nut
 For models
 prior to
 8/2018

Installation Tool

118305



D-Cell Battery Box
 (Batteries not included)

182421

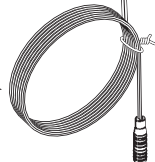

Soap Tube, O-ring,
 Spout Barb, & Soap Net
 (Tube Sheathing not included)
 (Nylon Washer is for use on
 models made before Jan. 1, 2017)

182417

Mounting Bracket,
 Vandal Shield &
 Mounting Hardware
 (Key included)

182416

Soap Dispenser –
 Sensor, Bracket, & Screw
 (Only for use with
 Soap Dispenser)

182422

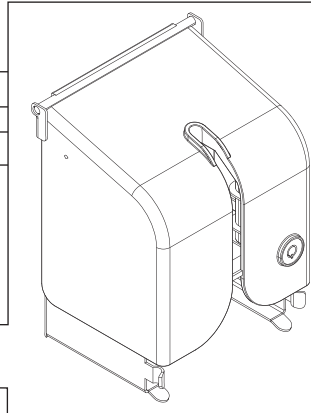

Electronics Box

182415

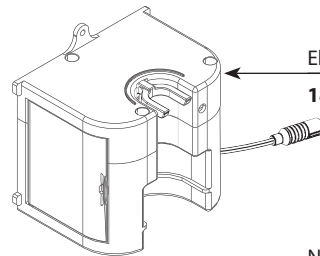

Non-drip Foam Soap Pump

182413

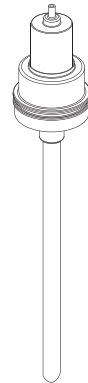

AC Conversion Kit

AC Transformer
 (up to 8 devices)
104630

Faucet AC Connector
 (1 per device)
182538

1500mL Soap Bottle

182414

