

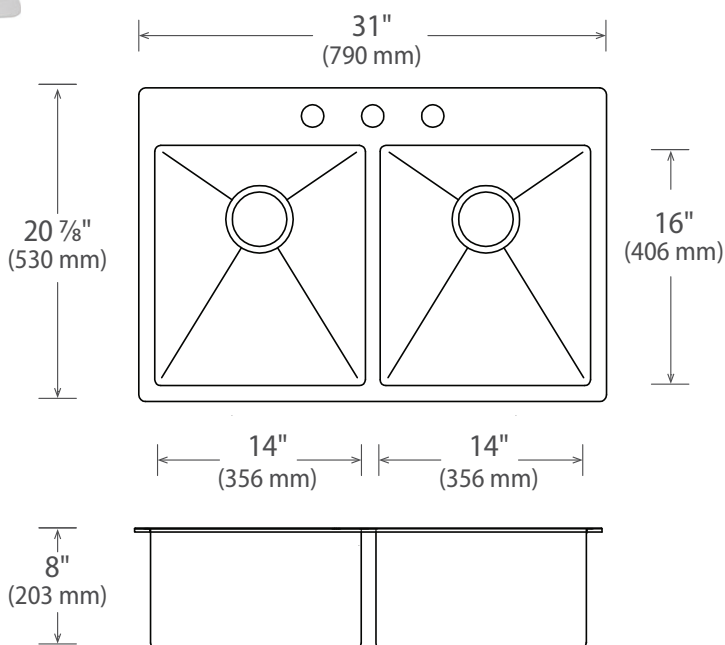

Features

- Hand Fabricated Stainless Steel Sink
- 10mm Radius Corners
- Sound Deadening Pads
- Size: 31" x 20 7/8" x 8"
- Min. Cabinet Width: 33" (84cm)
- Finish: Brushed Satin
- Gauge: 18, T304 Stainless Steel
- Installed as either an undermount or top mount
- Includes installation hardware and template



All Novanni Elite sinks with a 3 1/2" drain opening include an all metal stainless steel strainer. The distinctive Novanni crumb cup with snowflake pattern features a conical design with a superior tight seal. A metal tailpiece is included.