

# RVH8424

TOPMOUNT WORKSTATION SINK

**RUVATI**<sup>®</sup>  
SPECIFICATION SHEET

## MATERIAL

True 16 Gauge Thickness  
Premium T304 Grade Stainless Steel  
18/10 Chromium/Nickel Content  
Commercial Brushed Finish



## FEATURES

- Heavy duty sound guard padding and undercoating
- Slanted bottom with elegant drain grooves for easy draining
- Dual-Tier Ledge for Accessories



## IN THE BOX

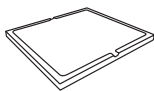

Cutting Board  
[RVA1233]

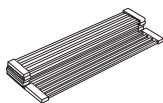

Folding Rack  
[RVA1395]

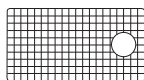

Rinse Grid  
[RVA68424]



Mixing Bowl and Platform  
[RVA1288]



Basket Strainer  
[RVA1025]



Drain Cover  
[RVA1035]

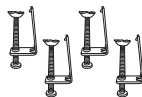

Mounting Clips  
[RVA11042]



Cut-out  
Template

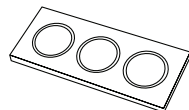

Condiment  
Serving Tray  
[RVA1377]

## NOMINAL DIMENSIONS

Exterior: 33" (wide) x 22" (front-to-back)  
Interior Bowl: 31" (wide) x 16" (front-to-back)  
Bowl Depth: 10"  
Minimum Cabinet Size: 36" wide  
Drain Hole Size: 3½"

**Installation Type:**  
Topmount  
**Inside Corners:**  
Zero Radius  
**Drain Location:**  
Offset

**RUVATI USA**  
www.ruvati.com

Phone: 1.855.478.8284  
Email: support@ruvati.com

## OPTIONAL ACCESSORIES (SOLD SEPARATELY)



Deep Basket  
Disposal Flange  
[RVA1049ST]

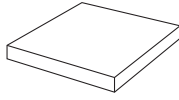

Butcher Block  
[RVA2445ACA]

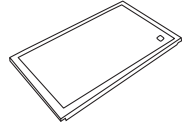

Black Plastic  
Cutting Board  
[RVA1217BLK]

## DIMENSIONS

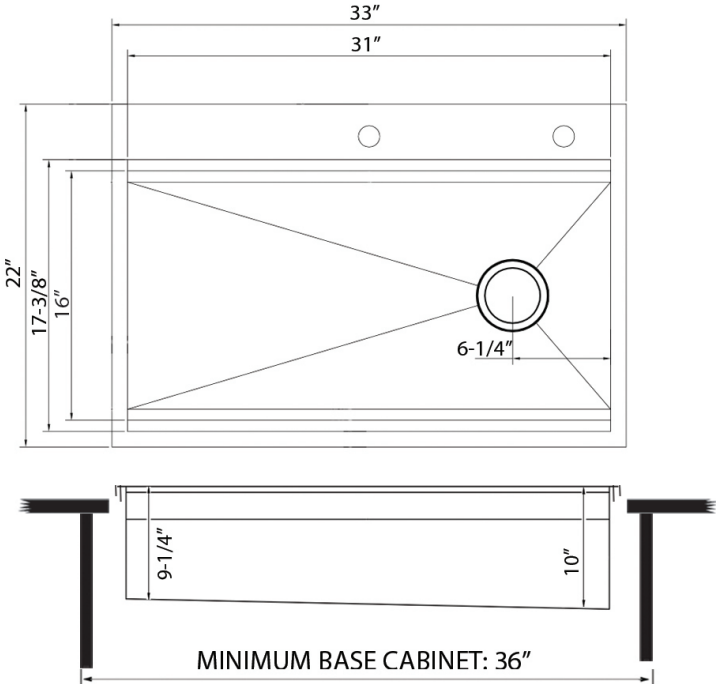

Register your product at [www.ruvati.com/register](http://www.ruvati.com/register).