

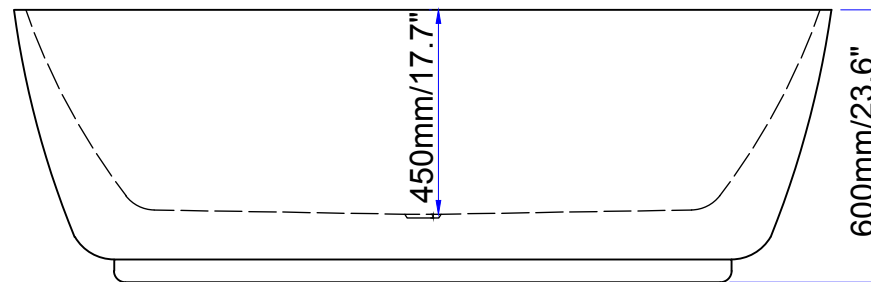

Streamline

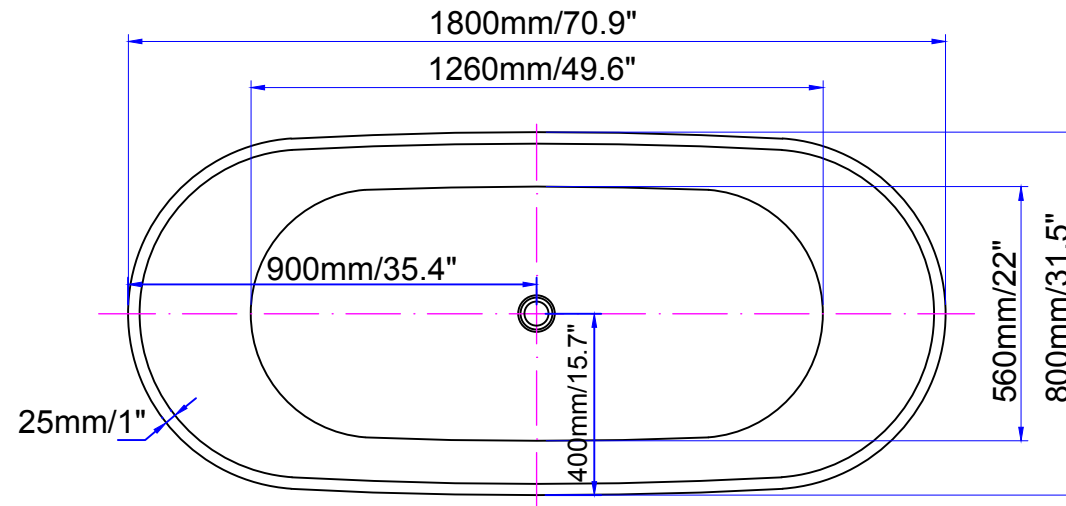

N-562-71FSWH-FM

