

FRONT VIEW

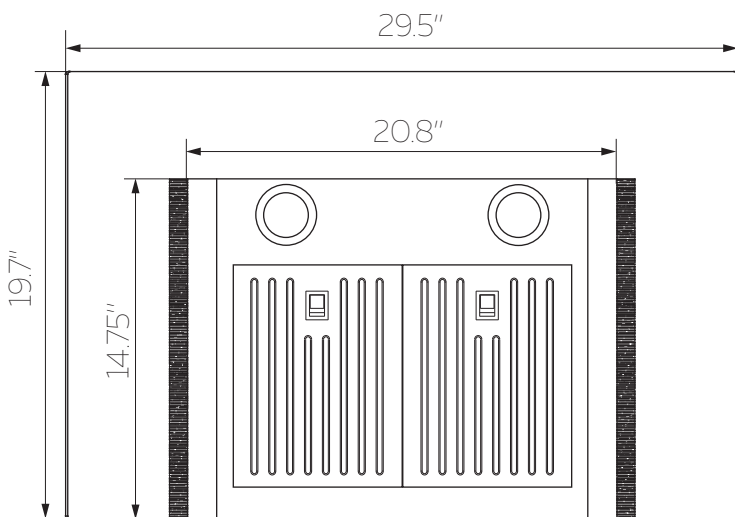

VIEW FROM UNDER

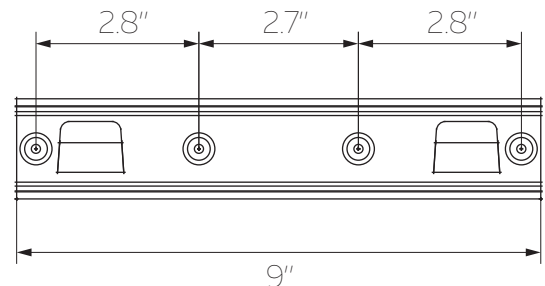

LOWER BRACKET

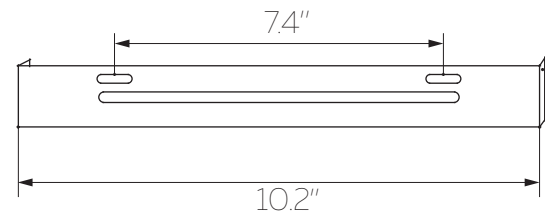

UPPER BRACKET

Overall Dimensions	30" W x 20" L x 21.2" H
Installation Type	Wall Mount
Exhaust Method	Convertible
Material	Stainless Steel

Noise Level	42-63dB(A)
Min/Max CFM	100-480
Speed & Control Type	3 Speed Touch Pad
Warranty	3 Year Limited Warranty