

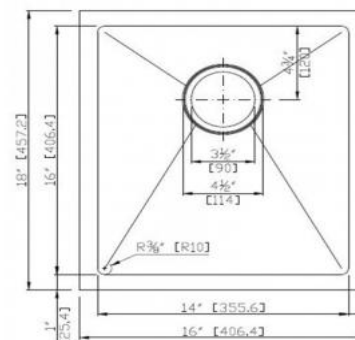

INSTALLATION MANUAL

S-309G
PEARL

Undermount
Stainless Steel
Kitchen Sink







Installation Guide

Undermount Stainless Steel Sink



S-309G PEARL

IMPORTANT NOTICES:

	PLEASE CAREFULLY READ COMPLETE INSTRUCTIONS BEFORE BEGINNING INSTALLATION. THIS INSTRUCTIONS ARE FOR INSTALLATIONS WITH SOLID SURFACES
	FOR BEST RESULTS, WE STRONGLY RECOMMEND THE INSTALLATION OF THIS SINK BE DONE BY A PROFESSIONAL PLUMBER
	SHUT OFF THE WATER SUPPLY BEFORE REMOVING EXISTING SINK
	DRAWING ARE FOR REFERENCE ONLY,REFER TO ACTUALSINK FOR PRODUCT SIZE AND SHAPE. USE PHYSICAL SINK TO ENDURE ACCURATE CUTOUT OPENING

INSTALLATION STEPS:

- Supplied cut-out template provides flush mount installation. Sink edge is flush with countertop opening. Place cut-out template in desired position on countertop locating center of the bowl over cabinet and faucet holes

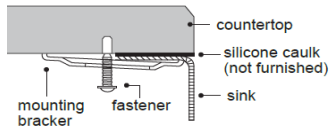

- Trace the outline of the template and cut countertop according to templated outline using appropriate cutting tools. Template is for guide only. Use physical sink to ensure accurate cut-out opening

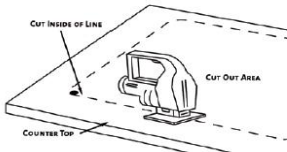

- Locate the drill holes on the underside of the countertop, approximately 1" from edge of the sink to be installed. Holes should be evenly spaced approximately 6" to 8" apart starting from every corner as shown below.

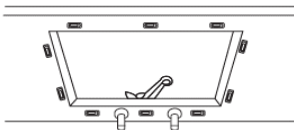

- Loosely attach mounting brackets to the countertop, parallel to the cut-out opening using the supplied mounting screws and nuts. Mounting screws with brass inserts are supplied with the sink, however, countertop material vary and the correct type of fasteners should be recommended by your installer or countertop supplier. Alternatively the installer may use wood studs or silicon caulk to hold the sink against then surface without using the supplied screws.
- Clean sink flange and underside of cut-out area of countertop, making sure that the area is smooth and free of grease. Apply continuous bead of silicone caulk evenly on top of sink flange

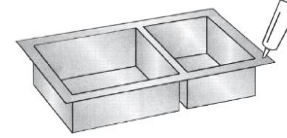

- Check alignment of sink again and tighten fasteners to secure sink. Wipe away excess silicone caulk with damp cloth. Connect drain and water supply according to manufacturer's instruction

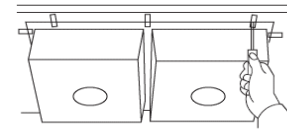

CARE AND CLEANING:

Regular cleaning of your sink is the best means of preserving and extending the life of your stainless steel sink as well as maintaining its original beauty. Rinse and dry your sink with a clean soft cloth, working with, not across, the grain; to prevent surface spots and lime build up stains caused by the water we use. We recommend the use of a mild solution of water and vinegar to remove any mineral deposits that may have built up on your sink. Again, rinse thoroughly and wipe dry to prevent water spots. Use mild non-abrasive liquid cream cleaners that do not contain chlorine, sodium hypochlorite or hydrochloric acid to help maintain the original appearance of your sink. Ensure that you thoroughly rinse your sink and wipe it dry again. FLITZ & BAR KEEPERS FRIEND are all effective at removing "surface" residue such as: tarnish, rust, lime deposits & hard water stains. We recommend the use of a stainless steel bottom grid that will protect the sink from scratches that could be caused by the utensils and pots.

WHAT NOT TO DO:

- * Do not use any abrasive sponge pads, wire brushes, metal scrub packs or steel wool as
- * Cleaners containing chloride, sodium hypochlorite or hydrochloric are not recommended.
- * It is not recommended to cut objects on the surface of your sink or to drop objects into the sink, especially sharp objects,as your stainless steel sink can be scratched or damaged
- * Do not pour paint into your sink or mark the surfaces with any form of ink product. The chemicals in paint and ink will permanently mark your sink. If this does occur consult the paint remover manufacturer before using any paint remover product on your sink
- * Do not defrost frozen food directly on the surface of your sink as it will discolour the stainless
- * Do not leave wet sponges or cloths in or on the sink surface for long periods of time as they too may discolour the sinks. Similarly, the use of rubber coated mats may discolour the sink under prolong use