



Vinnova Inc.

INSTALLATION SPECIFICATION

Item No.	301068-BP-PC
Description	By-pass
Overall Dimensions	68"x76"
Installation Size Range	64"-68"
Profile Color	Polished Chrome
Glass Thickness	8/25"
Glass Color	Transparent&Easy clean
Gross Weight	162 LBS
Certifications	ANSI Z97.1-2015

All measurements are approximate. Measurements may vary +/- 1/25".

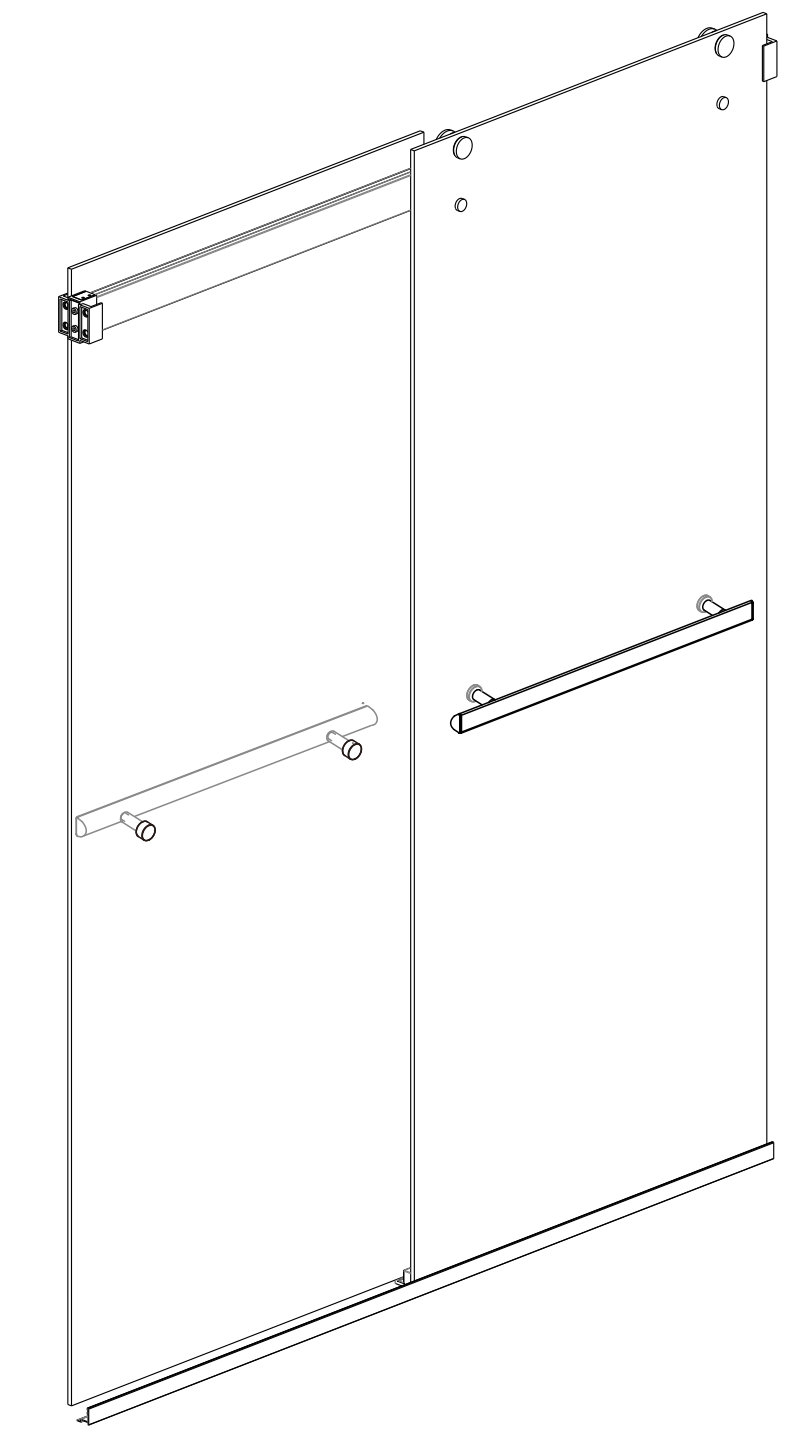

**Spezia
By-pass**

