



Vinnova Inc.

## INSTALLATION SPECIFICATION

Item No.	301160-BP-PC
Description	By-pass
Overall Dimensions	60"x58"
Installation Size Range	56"-60"
Profile Color	Polished Chrome
Glass Thickness	8/25"
Glass Color	Transparent&Easy clean
Gross Weight	116 LBS
Certifications	ANSI Z97.1-2015

*All measurements are approximate. Measurements may vary +/- 1/25".*

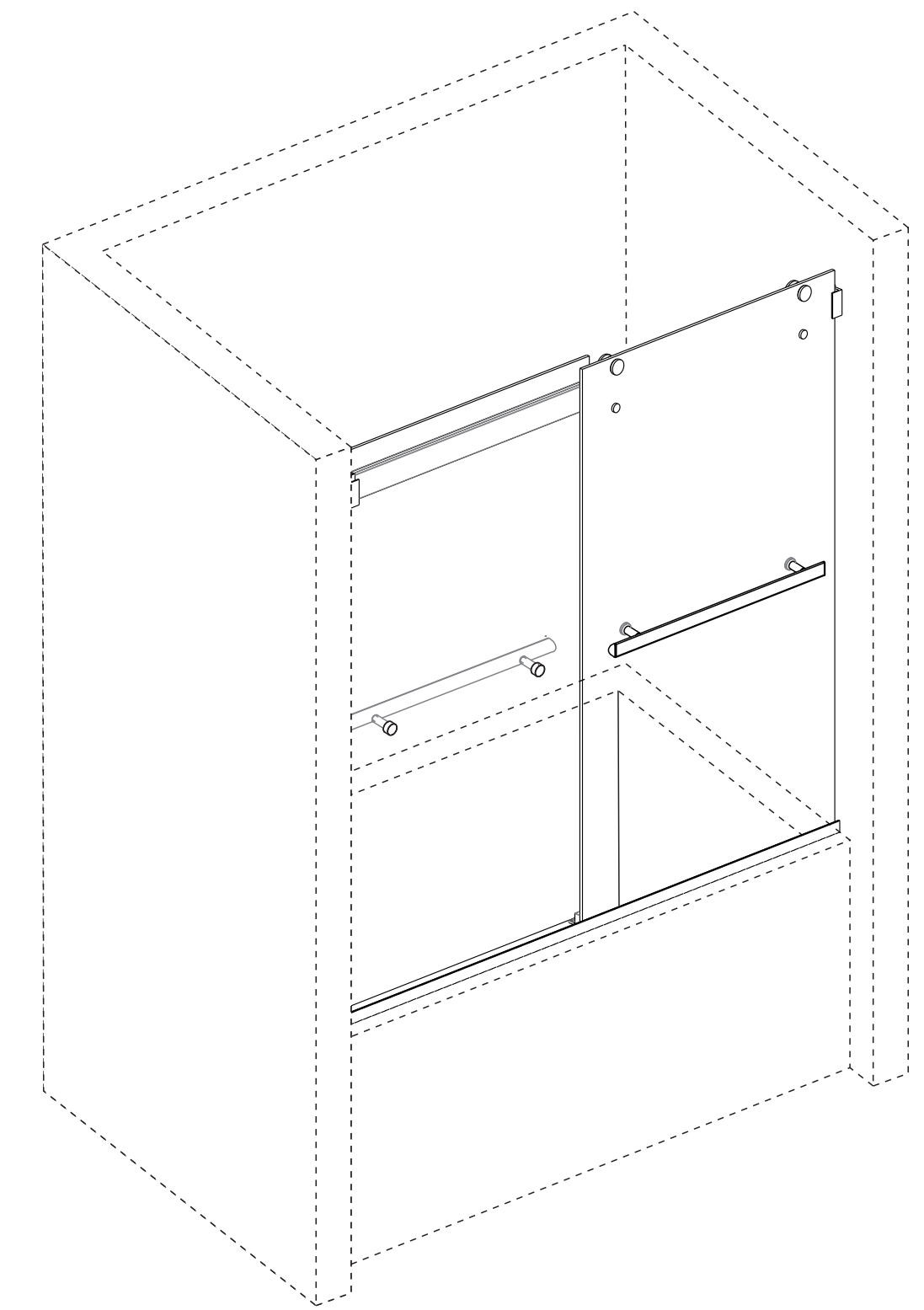

**Spezia  
By-pass**

