

- | | |
|---------------------------|----------------------------|
| [1] Bumper Strip | [11] Handle |
| [2] Fixed Tip | [12] Glass Door Stopper |
| [3] Side Panel | [13] Roller |
| [4] Wall Brace | [14] Glass Door |
| [5] Screw M5X30 | [15] Upper Guide Rail |
| [6] Anti-splash Threshold | [16] Side Anti-Water Strip |
| [7] Guide Block | [17] Glass Bracket |
| [8] Wall Anchor | [18] Screw M5X60 |
| [9] Floor Brace | [19] Guide Rail Bracket |
| [10] Screw M4X30 | [20] Fixed Panel |
| | [21] Allen Key |

● Box Contents:

[1] 1X Bumper Strip	➔	
[2] 1X Fixed Tip	➔	
[3] 1X Side Panel	➔	
[4] 2X Wall Brace	➔	
[5] 4X Screw M5X30	➔	
[6] 1X Anti-splash Threshold	➔	
[7] 1X Guide Block	➔	
[8] 7X Wall Anchor	➔	
[9] 2X Floor Brace	➔	
[10] 2X Screw M4X30	➔	
[11] 1X Handle	➔	
[12] 2X Glass Door Stopper	➔	
[13] 4X Roller	➔	
[14] 1X Glass Door	➔	
[15] 1X Upper Guide Rail	➔	
[16] 1X Side Anti-Water Strip	➔	
[17] 2X Glass Bracket	➔	
[18] 1X Screw M5X60	➔	
[19] 2X Guide Rail Bracket	➔	
[20] 1X Fixed Panel	➔	
[21] 5X Allen Key	➔	



● Assembly

01

WARM TIPS

01:

Open the packaging carefully and inspect all the necessary parts using detailed diagram and component list in your manual as a reference. Before discarding the carton, check for small hardware bags that tend to fall to the bottom of the box. If any parts are damaged or missing, please contact us for replacement.

02:

Retain these installation instructions for future use if in need.

1. Measure the distance between two finished walls. This distance is marked as W.

Please see Fig a for details:

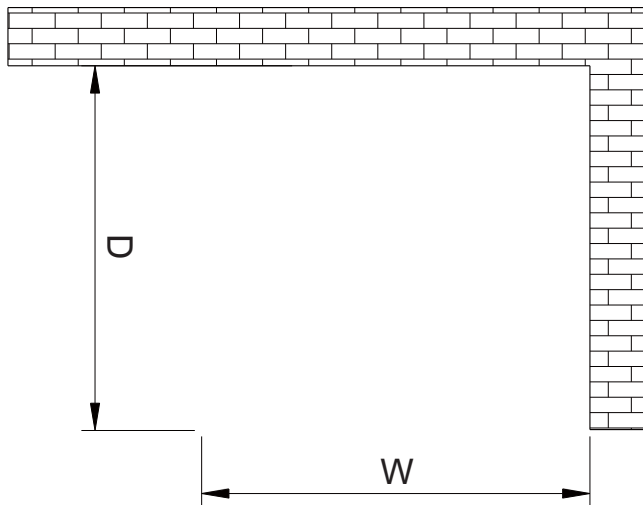

02

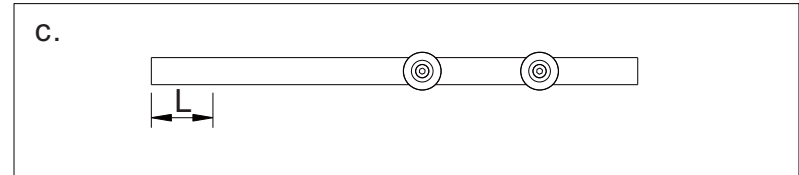
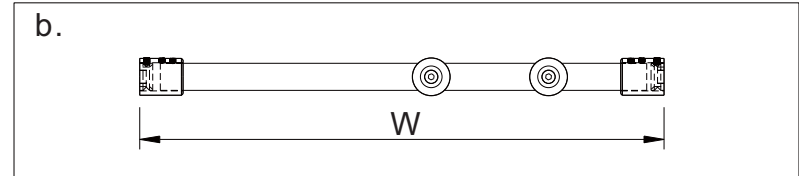
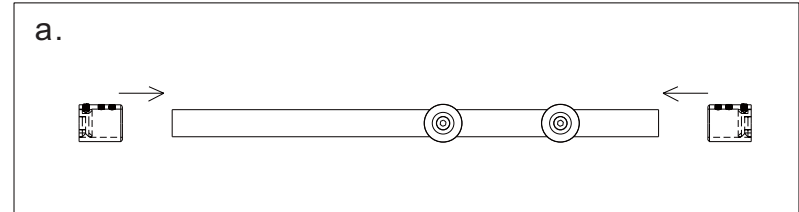





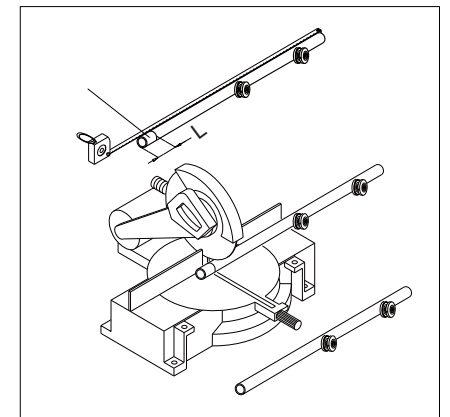

1. Your Upper Guide Rail (04) has been precut for your Shower model opening width, eg. 60" for shower width.
 If W-width of your wall-to-wall opening is equal to the size of your Shower model, it is unnecessary to cut the Upper Guide Rail and you can continue to Step 3.

If W-width of your wall-to-wall opening is less than the size of your Shower model, you will need to cut the Upper Guide Rail from the end which is farther from the Glass brackets (17) holes.
 The length to cut off will be L:
 $L = \text{Shower model size} - W$

FOR EXAMPLE
 If your wall opening W=59". Your shower model is 60".
 $L = 60 - 59 = 1"$
 You have to cut 1" off from the rail.





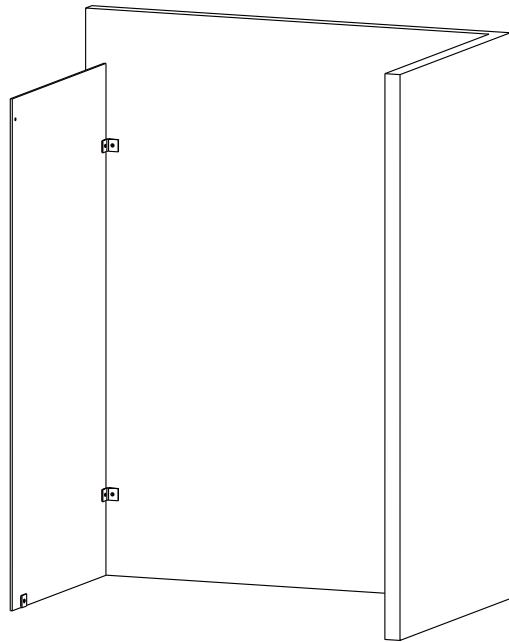

03

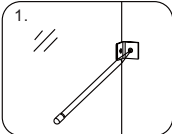
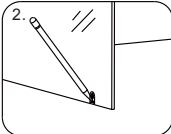
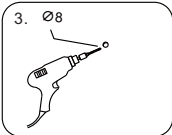
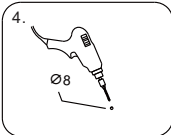
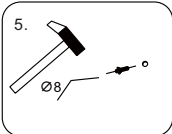
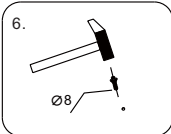
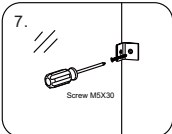
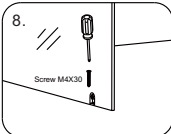
[4]		2X
[5]		2X
[9]		1X
[10]		1X
[8]		3X
[3]		1X





1. 
2. 
3. 
4. 
5. 
6. 
7. 
8. 

04

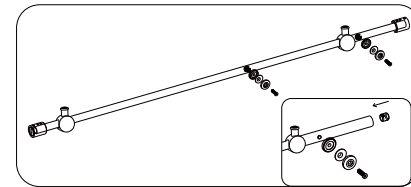
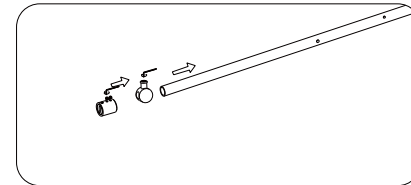
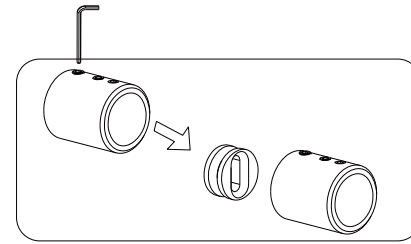
[19]		2X
[17]		2X
[12]		2X
[15]		1X





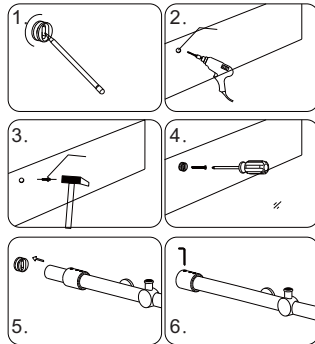
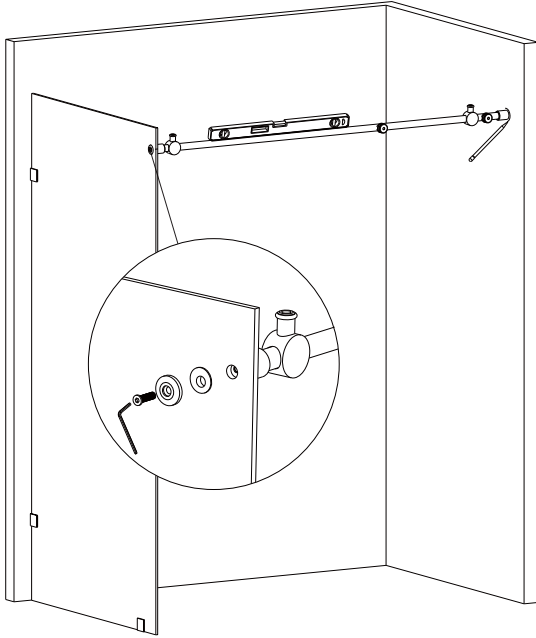

05

[2]		1X
[18]		1X
[8]		1X



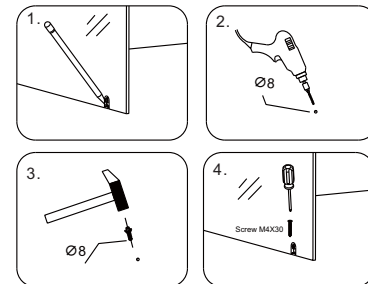
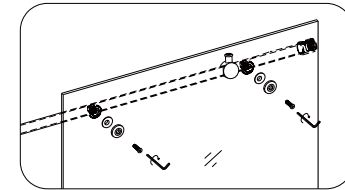
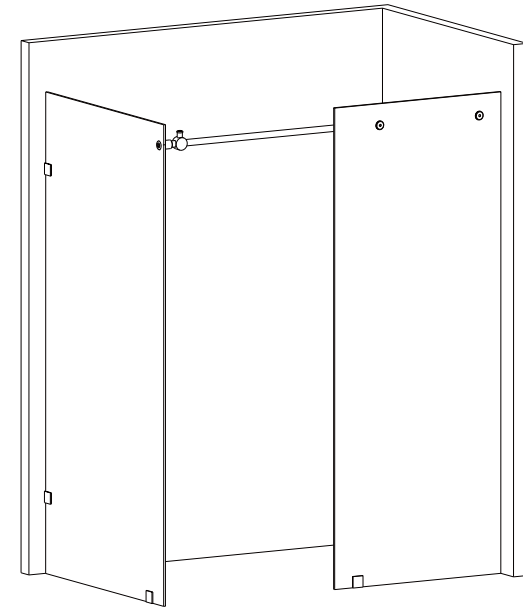

06

[20]		1X
[10]		1X
[8]		3X
[9]		1X



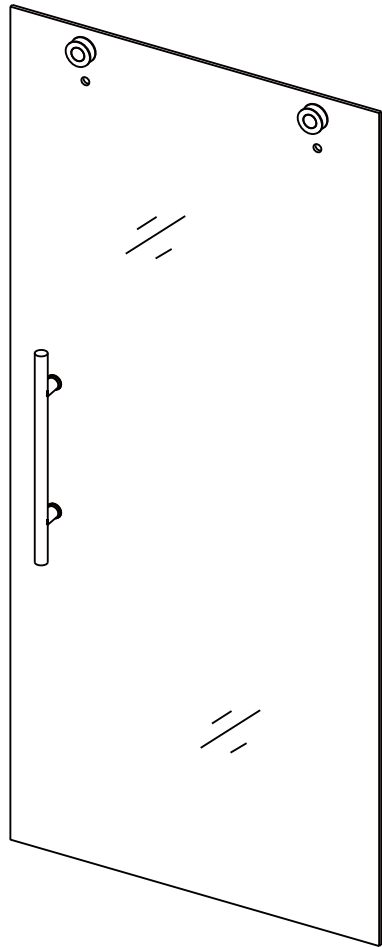
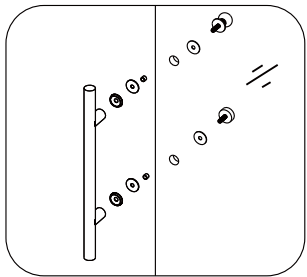
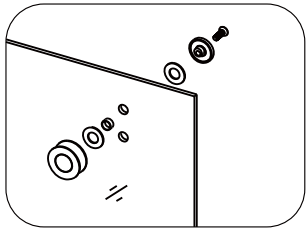
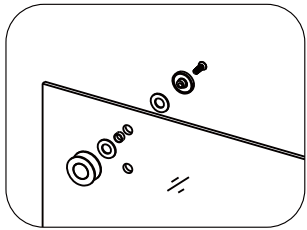

07

[13]	 2X
[11]	 1X
[14]	 1X



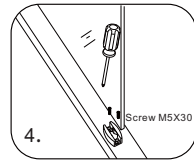
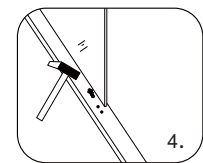
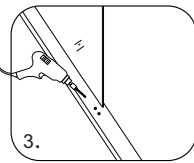
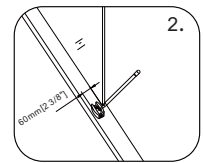
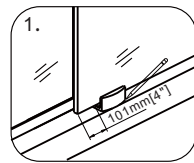
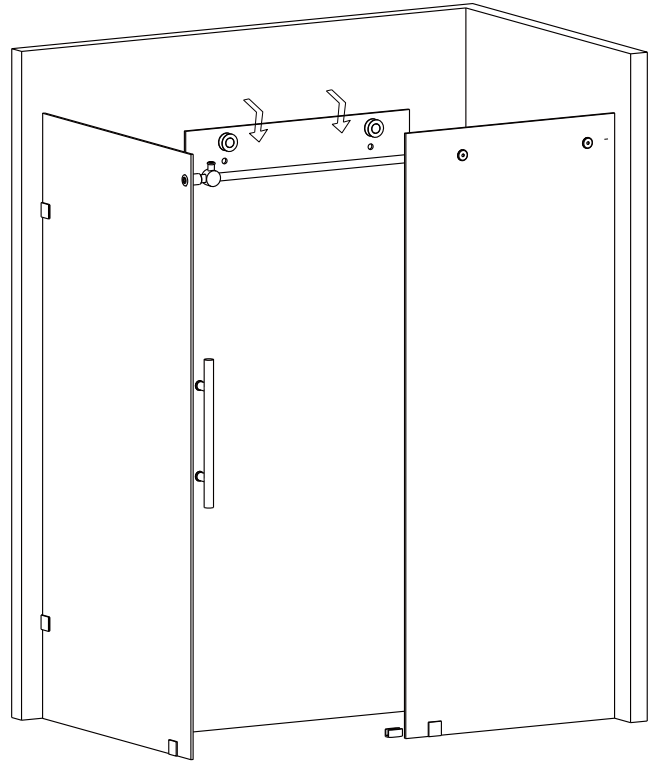

08

[7]	 1X
[5]	 2X
[8]	 2X



09

[1]		1X
[16]		1X
[13]		2X

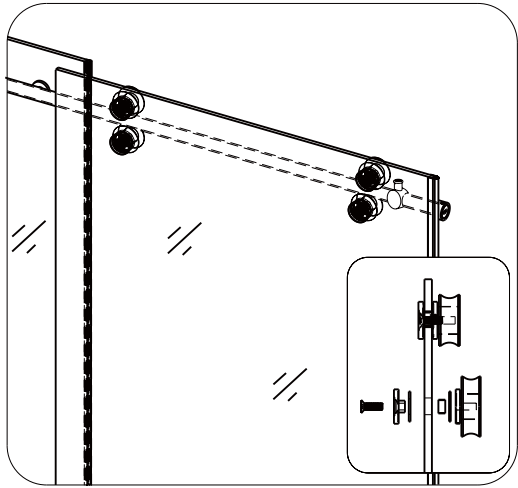
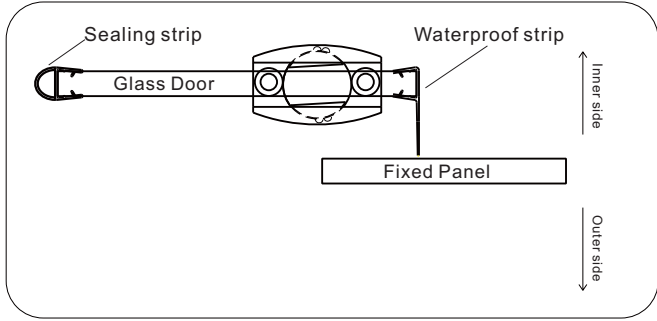

10

[6]		1X
-----	---	----

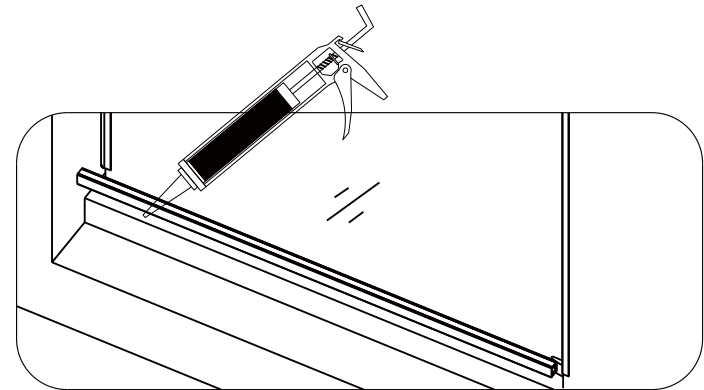
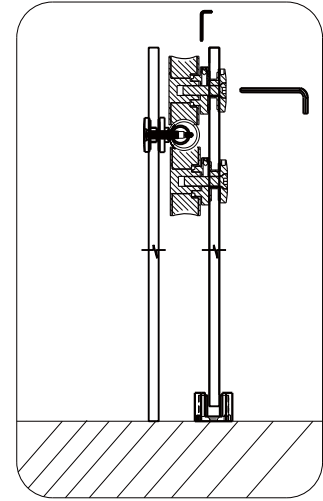
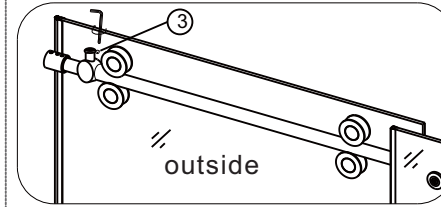
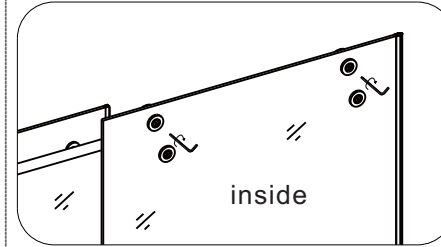

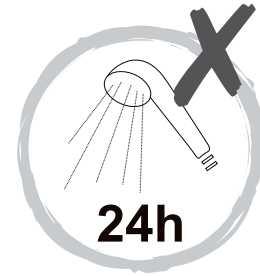
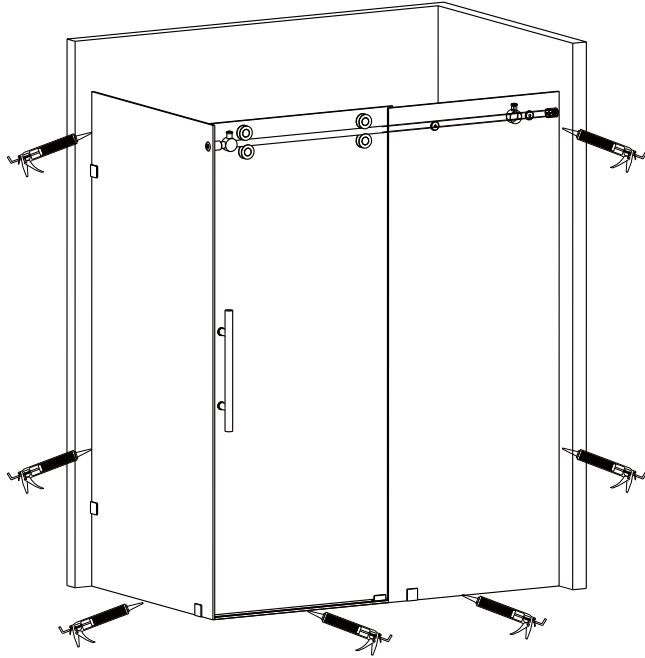

Please ensure the bottom horizontal is straight before the silicone sealant to cure fully



Do not use the shower enclosure for at least 24 hour in order to allow the silicone sealant to cure fully.