

CONTEMPORARY GANTRY FAUCET / 18" ARTICULATED SPOUT / 3PC. SUITE **3710-18-3**

- Max Counter Thickness 2-3/8"
- Minimum Install Hole Size 1-3/8"

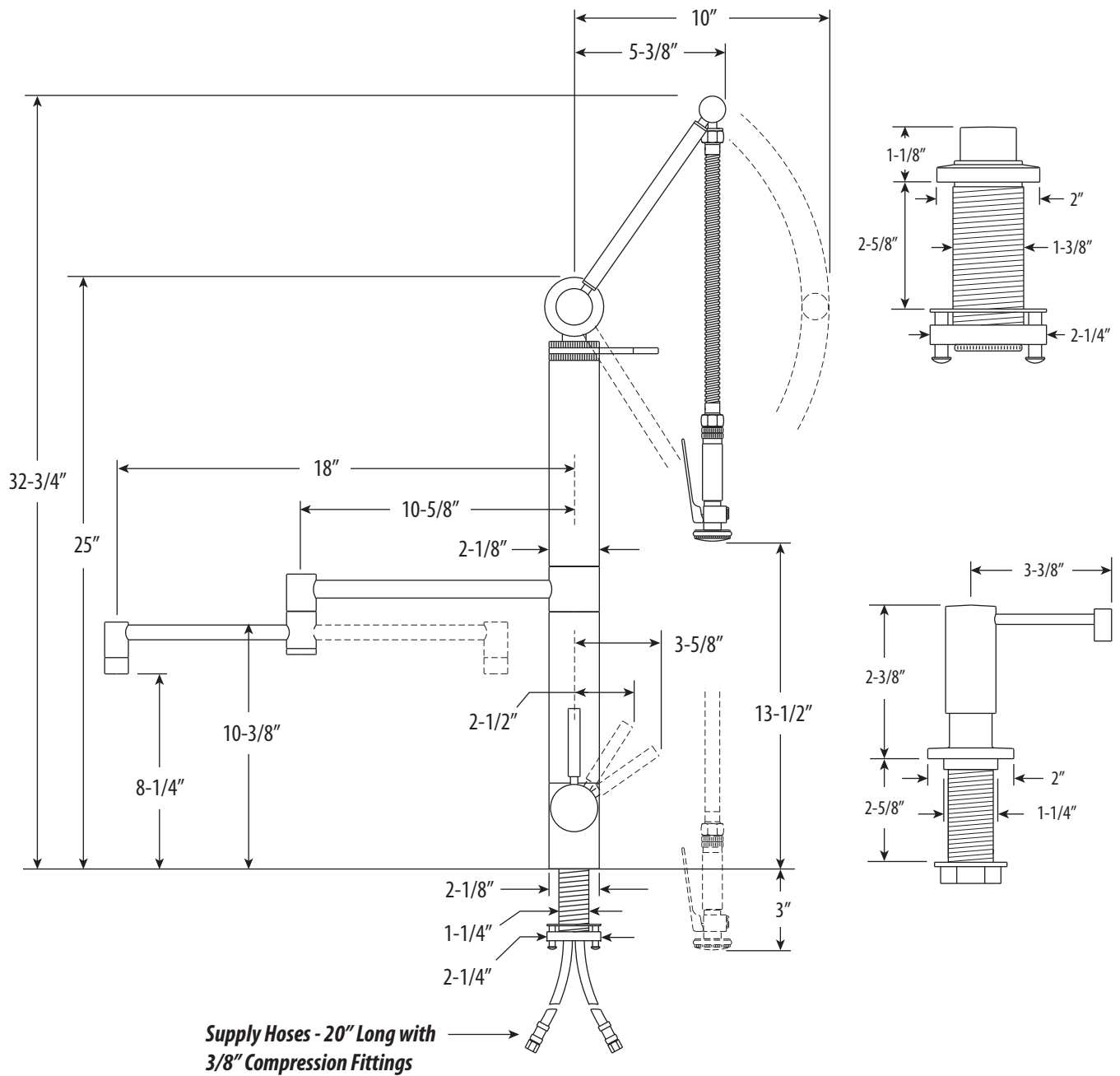

DIMENSIONS MAY VARY AND ARE SUBJECT TO CHANGE. NO RESPONSIBILITY IS ASSUMED FOR USE OF SUPERCEDED OR VOIDED DATA

CONTEMPORARY GANTRY FAUCET / 18" ARTICULATED SPOUT / 3PC. SUITE **3710-18-3**



Finish Shown - Polished Nickel

FEATURES

- Suite includes faucet, soap/lotion dispenser and air switch.
- Unique, patent protected design.
- Spray arm spring technology gives the sprayer an easy, smooth pull.
- Articulated spout has 18" reach and can swivel 360 degrees.
- Spray arm extends and pivots to reach all areas of sink.
- Lever handle sprayer instantly diverts water from aerated stream to wide spray when handle is held.
- 1.75 gpm maximum flow rate with aerated tip.
- Adjustable tension ring helps handle feel and prevents sag.
- Single handle can mount in front, right or left hand positions.
- When mounted on side, handle can adjust 22.5 degrees for backsplash clearance.
- Hot/cold ceramic disk valve cartridge.
- Resistant to reverse osmosis water.
- Made from solid brass or 316 stainless steel.
- Reinforced braided connection hoses.
- Includes reversible or removable hot/cold indicator ring.
- Lifetime functional warranty.
- Made in the USA.

CODES/STANDARDS APPLICABLE

Specified model meets or exceeds the following:

- **ASME A112.18.1**
- **CSA B125.1**
- **NSF 61, 372**
- **CALGreen**



AVAILABLE IN 30 FINISHES + SOLID 316 MARINE GRADE STAINLESS STEEL