

TRADITIONAL 3" CABINET DRAWER PULL

HTP-0300

- Break to length screws
- Fits materials from 1/2" to 1-1/2" thick

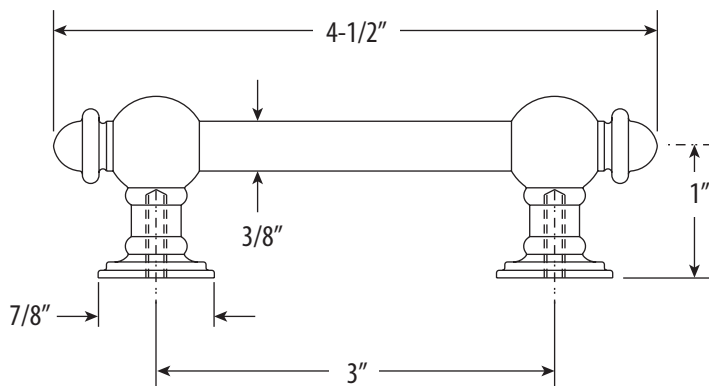

Finish Shown - Antique Pewter

FEATURES

- 3" wide on center.
- Matches all Waterstone traditional faucets.
- Perfect for traditional kitchen cabinets or drawers.
- Made from eco-friendly solid brass.
- Includes mounting hardware.
- Break to length screws.
- Fits materials from 1/2" to 1-1/2" thick.
- Made in the USA.



DIMENSIONS MAY VARY AND ARE SUBJECT TO CHANGE. NO RESPONSIBILITY IS ASSUMED FOR USE OF SUPERCEDED OR VOIDED DATA

AVAILABLE IN 32 FINISHES + SOLID 316 MARINE GRADE STAINLESS STEEL