

## TRADITIONAL 24" APPLIANCE PULL

# HTP-2400

- Break to length screws
- Fits materials from 1/2" to 1-1/2" thick

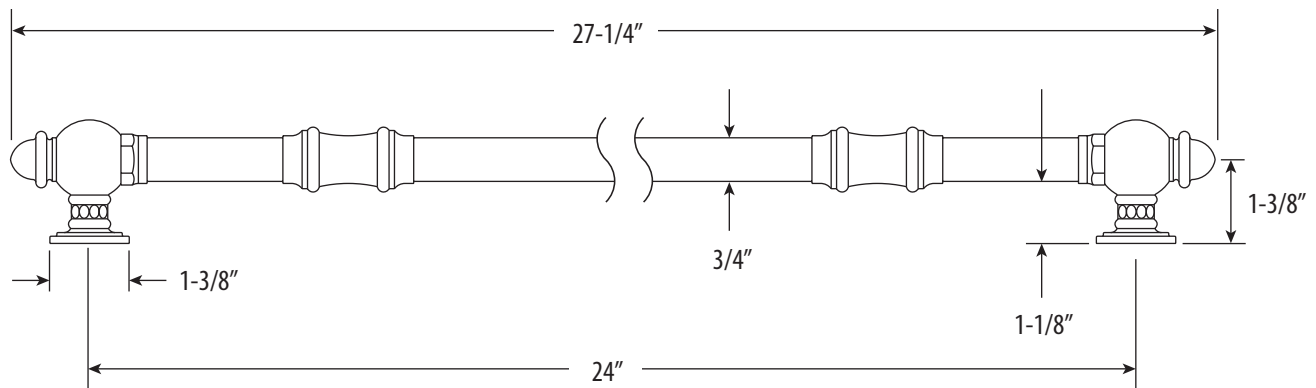

*DIMENSIONS MAY VARY AND ARE SUBJECT TO CHANGE. NO RESPONSIBILITY IS ASSUMED FOR USE OF SUPERCEDED OR VOIDED DATA*

### FEATURES

- Ideal for refrigerators or dishwashers.
- 24" wide on center.
- Matches all Waterstone traditional faucets.
- Brings the entire kitchen together.
- Made from solid eco-friendly brass.
- Includes mounting hardware.
- Break to length screws.
- Fits materials from 1/2" to 1-1/2" thick.
- Made in the USA.



Finish Shown - Antique Pewter

AVAILABLE IN 32 FINISHES + SOLID 316 MARINE GRADE STAINLESS STEEL